



HY11P33
Datasheet
8-Bit RISC-like Mixed Signal Microcontroller
Embedded 4x20 LCD Driver
18-Bit Σ ADC

Table of Content

1. FEATURES	5
2. PIN DEFINITION	6
2.1 HY11P33 LQFP64 Pin Diagram	6
2.2 HY11P33 Pinout I/O Description	7
3. APPLICATION CIRCUIT	10
3.1 Bridge Sensor I	10
4. FUNCTION DESCRIPTION.....	11
4.1 Internal Block Diagram.....	11
4.2 Related Description and Supporting Documents.....	11
4.3 SD18 Network.....	12
5. REGISTER LIST	13
6. ELECTRICAL CHARACTERISTICS.....	15
6.1 Recommended Operating Conditions	15
6.2 Internal RC Oscillator	16
6.3 Supply Current into VDD excluding Peripherals Current	17
6.4 Port1~2.....	19
6.5 Reset(Brownout, External RST pin, Low Voltage Detect)	20
6.6 Power System.....	22
6.7 LCD.....	24
6.8 SD18, Power Supply and Recommended Operating Conditions.....	25
6.8.1 PGA, Power Supply and Recommended Operating Conditions	25
6.8.2 SD18, Performance II (fSD18=250KHz)	25

HY11P33

Embedded 18-Bit $\Sigma\Delta$ ADC
8-Bit RISC-like Mixed Signal Microcontroller



6.8.3 SD18 Noise Performance	27
6.9 Built-In EPROM (BIE)	29
7. ORDERING INFORMATION	30
8. PACKAGE INFORMATION	31
8.1 LQFP64(L064)	31
9. REVISION RECORD	32

Notes:

1. Improvements and contents to this user guide necessitated by improvements to equipment may be made by Hycon Technology at any time and without notice. You may download the most up to date version of this user guide at <http://www.hycontek.com>.
2. Under no circumstances will Hycon Technology be liable in any way for third party copyright problems concerning graphs and application circuits contained in this user guide.
3. Hycon Technology guarantees that features, typical applications and functions of this product are compliant with this user guide when being used in stand-alone situation. Hycon Technology does not make the same guarantee when this product is used together with your finished goods or equipment. Hycon Technology advises you to conduct comprehensive evaluations and tests.
4. You, and not Hycon Technology, are responsible for making sure that the internal power consumption of IC is within limits given in this user guide by following the using conditions of input voltage, output voltage, and load current. Under no circumstances will Hycon Technology be liable in any way for damage caused by your using this product, even for a very short period of time, in conditions exceeding limits specified in this user guide.
5. In spite of embedded static protection circuit of this product Hycon Technology advises you do not apply static that is over protection circuit capacity.
6. Hycon Technology advises you not to use this product in mission critical circuits or components of mission critical circuits unless authorized with prior written permission. This may include, but not limited to, health and medical equipment, disaster prevention equipment, vehicles, automotive equipment, aviation equipment, and equipment and devices that may affect human body.
7. Hycon Technology strives to improve quality and reliability of this product. However every semiconductor will fail at certain probability and this may cause personal injury and/or fire. Hycon Technology advises you to pay special attention to redundancy and safety level in designing your end product. This may prevent incidents and accidents from happening.
8. Transfer and reproduction of part or all of the contents in this user guide in any format without the prior permission of Hycon Technology is prohibited.

1. Features

- 8-bit RISC, 66 instructions included.
- Operating voltage range: 2.2V to 3.6V, operation temperature range: -40°C~85°C.
- External Crystal Oscillator and Internal High Precision RC Oscillator, 6 CPU clock rates enable users to have the most power-saving plan.
 - Active Mode 300uA@2MHz
 - Standby Mode 3uA@28KHz
 - Sleep Mode 1uA
- 4K Word OTP (One Time Programmable) Type Program Memory, 256 Byte Data Memory
- Brownout detector and Watch Dog Timer, prevents CPU from Crash.
- 18-bit fully differential input Sigma-Delta Analog-to-Digital Converter (A/D)
 - Built-in PGA (Programmable Gain Amplifier) 1/4x、1/2x、1x...128x、multiple input signal gain selection.
 - Built-in Input zero point adjustment can increase measurement range according to different application.
 - Conversion rate up to ~1.95ksps
- 1.0V internal analog circuit common ground that equips with Push-Pull drive ability to provide sensor driving voltage.
- LVD low voltage detection function has 14 steps of voltage detection configuration and external input voltage detection function.
- Analog voltage source, VDDA equips with 10mA low dropout regulator function
- 4x20 LCD Driver
 - 1/4 Duty, 1/3 Bias
 - Built-in Charge Pump regulated circuit, providing 4 LCD Bias voltage
- 8-bit Timer A
- 8-bit Timer C module can generate PWM/PFD function.
- Built-in EPROM (BIE)
- Support 6 stack level

HY11P33

Embedded 18-Bit Σ ADC
8-Bit RISC-like Mixed Signal Microcontroller

2. Pin Definition

2.1 HY11P33 LQFP64 Pin Diagram

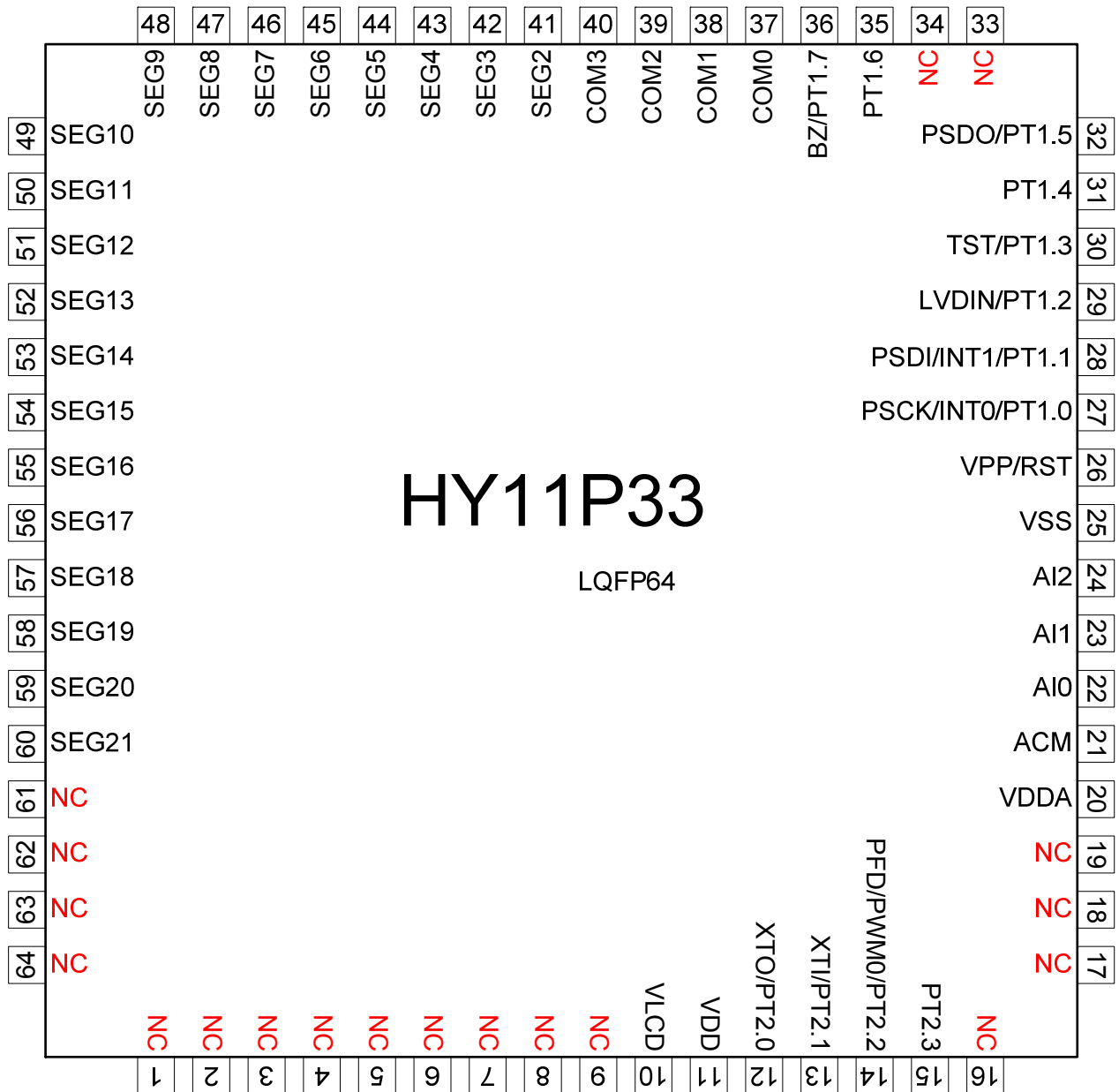

Figure 2-1 HY11P33 LQFP64 Pin Diagram

Note 1 : VPP and RST use the same pin. Input voltage cannot exceed 5.8V when not programming EPROM.

Note 2 : TST and PT1.3 use the same pin. Input voltage cannot exceed Vdd+0.3V while operating.

Note 3 : If PT1.3 is not configured as external pin button, it can help to enhance the anti-interference ability

2.2 HY11P33 Pinout I/O Description

"I/O" input/output, "I" input, "O" output, "S" Smith Trigger, "C" CMOS features compatible input/output, "P" power supply, "A" analog channel

No.	Pin Name	Pin Characteristics		Function Description
	HY11P33	Pin Type	Buffer Type	
1	NC	O	A	Segment output for LCD
2	NC	O	A	Segment output for LCD
3	NC	O	A	Segment output for LCD
4	NC	O	A	Segment output for LCD
5	NC	O	A	Segment output for LCD
6	NC	O	A	Segment output for LCD
7	NC	O	A	Segment output for LCD
8	NC	O	A	Segment output for LCD
9	NC	-	-	Unused
10	VLCD	P	P	Power supply for LCD
11	VDD	P	P	Power supply for IC operation
12	PT2.0/XTO	I/O	S	Digital I/O
		A	A	External Oscillator input pin
13	PT2.1/XTI	I/O	S	Digital I/O
		A	A	External Oscillator input pin
14	PT2.2/PWM0/PFD	I/O	C	Digital I/O
		O	C	PWM output port
		O	C	PFD output port
15	PT2.3	I/O	S	Digital I/O
16	NC	-	-	Unused
17	NC	-	-	Unused
18	NC	-	-	Unused
19	NC	-	-	Unused
20	VDDA	P	P	Regulator output, analog circuit power
21	ACM	P	P	Common ground pin for internal analog circuit
22	AI0	A	A	Analog input channel
23	AI1	A	A	Analog input channel

HY11P33

Embedded 18-Bit Σ ADC 8-Bit RISC-like Mixed Signal Microcontroller

24	AI2	A	A	Analog input channel
25	VSS	P	P	Ground pin of IC operation power supply.
26	RST/VPP	I P	S P	Reset IC EPROM programming voltage input
27	PT1.0/INT0/PSCK	I I I	S S S	Digital input Interrupt input INT0 OTP programming interface SDI
28	PT1.1/INT1/PSDI	I I I	S S S	Digital input Interrupt input INT1 OTP programming interface SDI
29	PT1.2/LVDIN	I A	S A	Digital input LVD external signal input pin
30	PT1.3/TST	I I	S S	Digital input Test Mode input pin (invalid)
31	PT1.4	I/O	S	Digital I/O
32	PT1.5/PSDO	I/O O	S C	Digital I/O OTP programming interface SDO
33	NC	-	-	Unused
34	NC	-	-	Unused
35	PT1.6	I/O	S	Digital I/O
36	PT1.7/BZ	I/O O	S C	Digital I/O Buzzer input pin
37	COM0	O	A	COM segment output for LCD
38	COM1	O	A	COM segment output for LCD
39	COM2	O	A	COM segment output for LCD
40	COM3	O	A	COM segment output for LCD
41	SEG2	O	A	Segment output for LCD

HY11P33

Embedded 18-Bit $\Sigma\Delta$ ADC
8-Bit RISC-like Mixed Signal Microcontroller

42	SEG3	O	A	Segment output for LCD
43	SEG4	O	A	Segment output for LCD
44	SEG5	O	A	Segment output for LCD
45	SEG6	O	A	Segment output for LCD
46	SEG7	O	A	Segment output for LCD
47	SEG8	O	A	Segment output for LCD
48	SEG9	O	A	Segment output for LCD
49	SEG10	O	A	Segment output for LCD
50	SEG11	O	A	Segment output for LCD
51	SEG12	O	A	Segment output for LCD
52	SEG13	O	A	Segment output for LCD
53	SEG14	O	A	Segment output for LCD
54	SEG15	O	A	Segment output for LCD
55	SEG16	O	A	Segment output for LCD
56	SEG17	O	A	Segment output for LCD
57	SEG18	O	A	Segment output for LCD
58	SEG19	O	A	Segment output for LCD
59	SEG20	O	A	Segment output for LCD
60	SEG21	O	A	Segment output for LCD
61	NC	O	A	Segment output for LCD
62	NC	O	A	Segment output for LCD
63	NC	O	A	Segment output for LCD
64	NC	O	A	Segment output for LCD

Table 2-1 Pin Definition and Function Description

HY11P33

Embedded 18-Bit $\Sigma\Delta$ ADC
8-Bit RISC-like Mixed Signal Microcontroller

3. Application Circuit

3.1 Bridge Sensor I

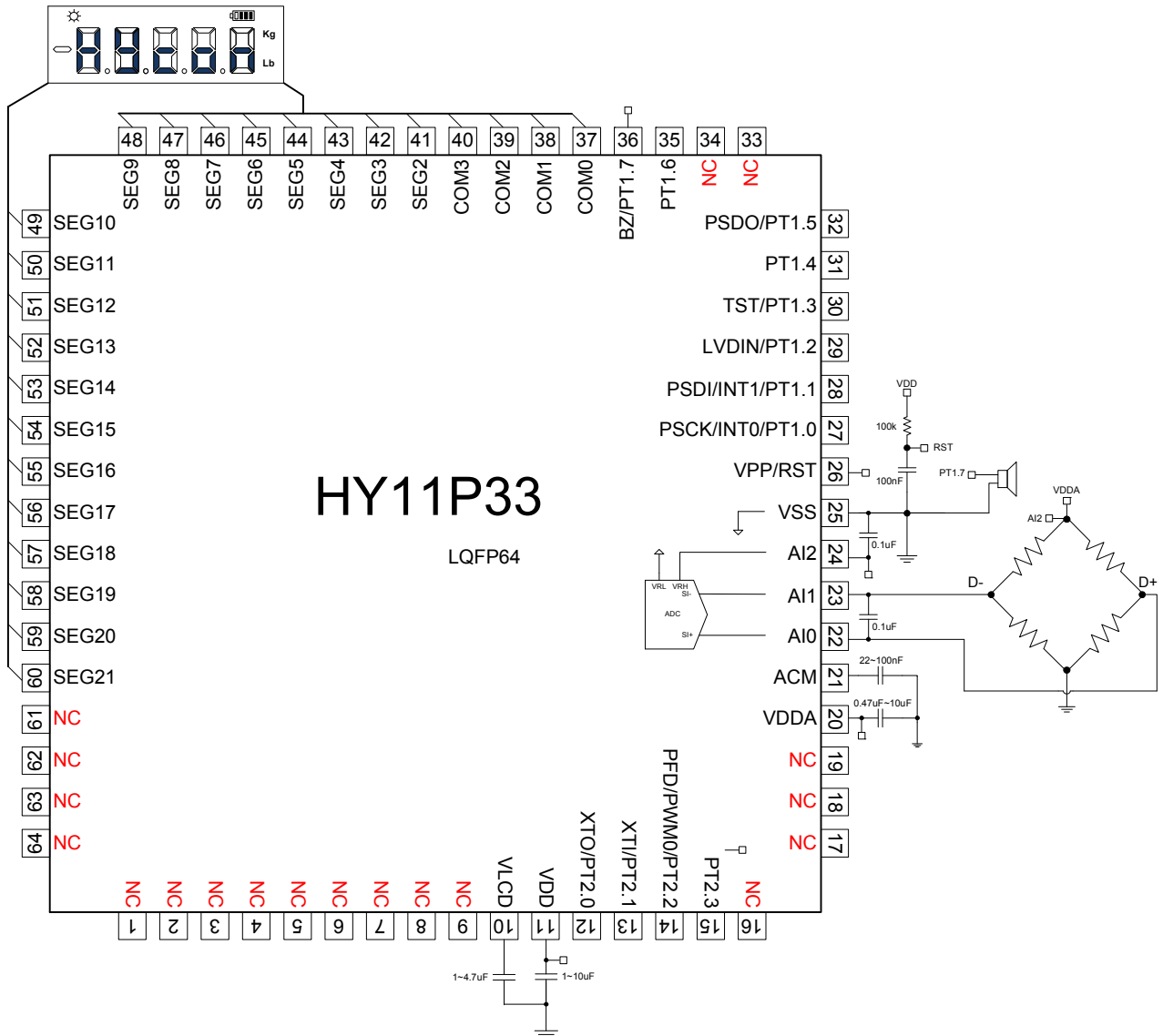
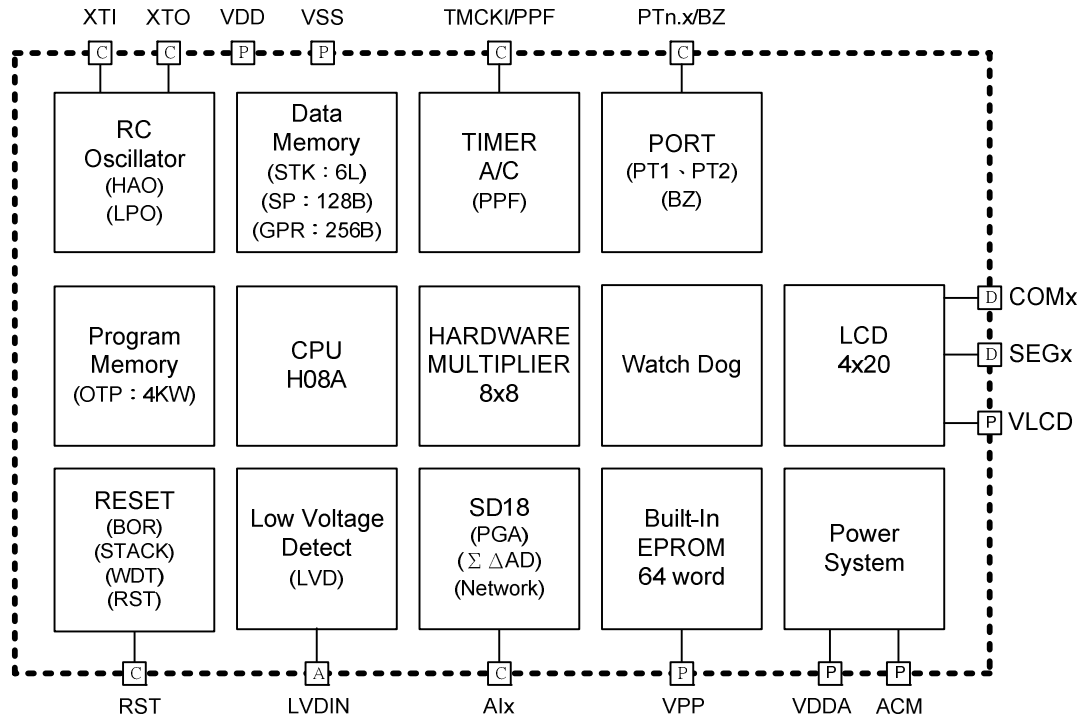

Figure 3-1 Application Circuit of Bridge Sensor

Note 1 : DCSET[2:0] can conduct bias adjustment of Load Cell zero point voltage address

4. Function Description

4.1 Internal Block Diagram



P Power Pad
 D Digital Pad
 A Analog Pad
 C Common I/O Pad

Figure 4-1 HY11P33 Internal Block Diagram

4.2 Related Description and Supporting Documents

IC Function Related Operating Instruction

DS-HY11P33-Vxx	HY11P33 Datasheet
UG-HY11S14-Vxx	HY11Pxx Series User's Manual
APD-CORE002-Vxx	H08A Instruction Description

Development Tool Related Operating Instruction

APD-HYIDE006-Vxx	HY11xxx Series Development Tool Software Instruction Manual
APD-HYIDE005-Vxx	HY11xxx Series Development Tool Hardware Instruction Manual
APD-OTP001-Vxx	OTP Products Programming Pin Manual

Product Production Related Operating Instruction

APD-HYIDE004-Vxx	HY1xxxx Series Production Line Specialized Programmer Manual
BDI-HY11P33-Vxx	HY11P33 Individual Product Die Bonding Information

4.3 SD18 Network

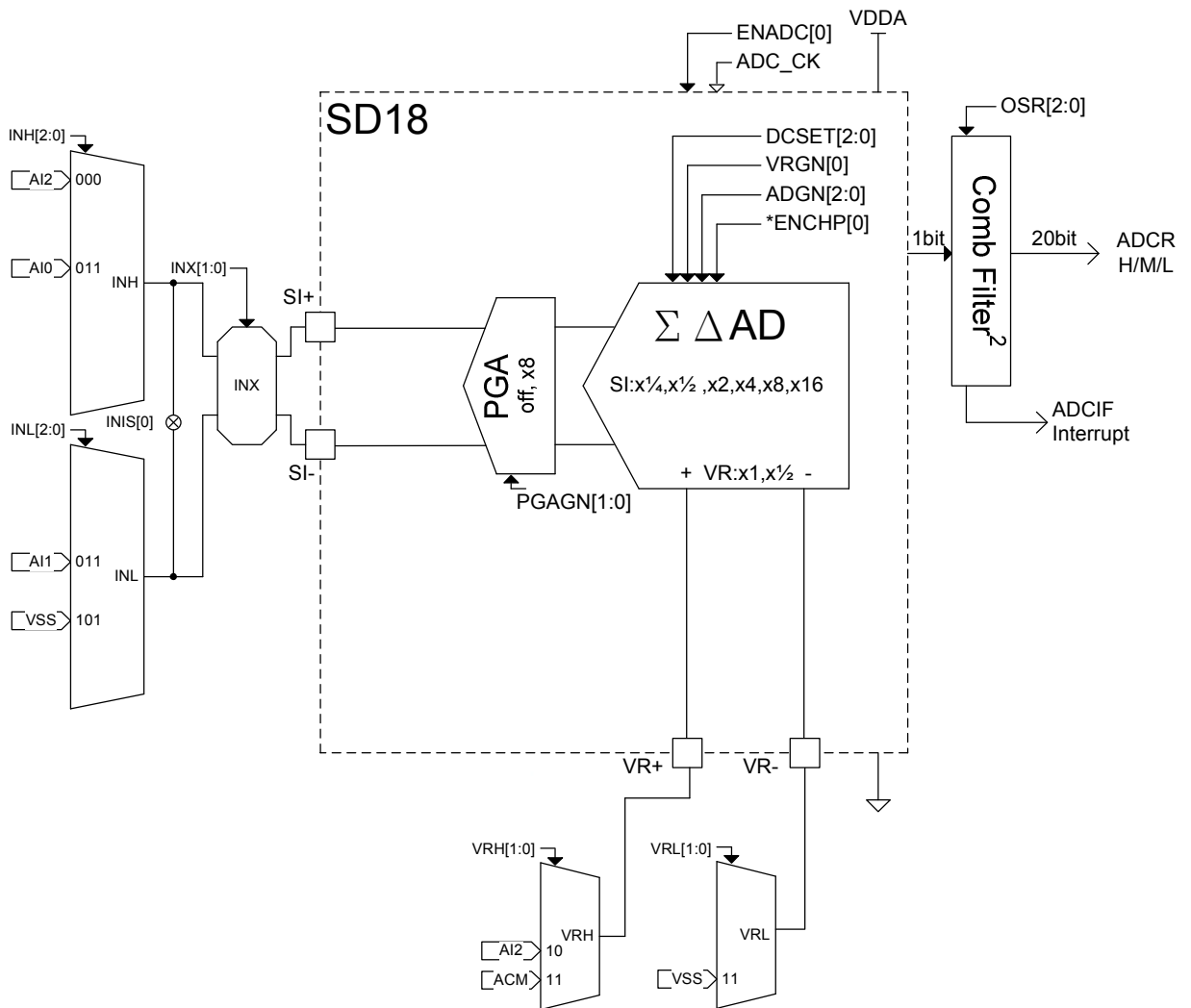

Figure 4-2 SD18 Network

5. Register List

"n"no use,"**"read/write,"w"write,"r"read,"r0"only read 0,"r1"only read 1,"w0"only write 0,"w1"only write 1 "u"unimplemented bit,"x"unknown,"u"unchanged,"d"depends on condition																
Address	File Name	Bit7	Bit6	Bit5	Bit4	Bit3	Bit2	Bit1	Bit0	A-RESET	i-RESET	R/W				
00H	INDF0	Contents of FSR0 to address data memory value of FSR0 not changed								N/A	N/A	*****				
01H	POINC0	Contents of FSR0 to address data memory value of FSR0 post-incremented								N/A	N/A	*****				
02H	PODEC0	Contents of FSR0 to address data memory value of FSR0 post-decremented								N/A	N/A	*****				
03H	PRINC0	Contents of FSR0 to address data memory value of FSR0 pre-incremented								N/A	N/A	*****				
04H	PLUSW0	Contents of FSR0 to address data memory value of FSR0 offset by W								N/A	N/A	*****				
05H	INDF1	Contents of FSR1 to address data memory value of FSR0 not changed								N/A	N/A	*****				
06H	POINC1	Contents of FSR1 to address data memory value of FSR0 post-incremented								N/A	N/A	*****				
07H	PODEC1	Contents of FSR1 to address data memory value of FSR0 post-decremented								N/A	N/A	*****				
08H	PRINC1	Contents of FSR1 to address data memory value of FSR0 pre-incremented								N/A	N/A	*****				
09H	PLUSW1	Contents of FSR1 to address data memory value of FSR0 offset by W								N/A	N/A	*****				
0FH	FSR0H									FSR0[8]xu	*****			
10H	FSR0L	Indirect Data Memory Address Pointer 0 Low Byte,FSR0[7:0]								xxxx xxxx	uuuu uuuu	*****				
11H	FSR1H									FSR1[8]xu	*****			
12H	FSR1L	Indirect Data Memory Address Pointer 1 Low Byte,FSR1[7:0]								xxxx xxxx	uuuu uuuu	*****				
16H	TOSH					TOS[11]	TOS[10]	TOS[9]	TOS[8]00000000	*****				
17H	TOSL	Top-of-Stack Low Byte (TOS<7:0>)														
18H	STKPTR	STKFL	STKUN	STKOV									STKPTR[2:0]	000_000	000_000	r,rw0,rw0,-,r,r,r
1AH	PCLATH							PC[11]	PC[10]	PC[9]	PC[8]00000000	*****		
1BH	PCLATL	PC Low Byte for PC<7:0>														
1DH	TBLPTRH					TBLPTR[11]	TBLPTR[10]	TBLPTR[9]	TBLPTR[8]00000000	*****				
1EH	TBLPTRL	Program Memory Table Pointer Low Byte (TBLPTR<7:0>)														
1FH	TBLDH	Program Memory Table Latch High Byte														
20H	TBLDL	Program Memory Table Latch Low Byte														
21H	PRODH	Product Register of Multiply High Byte														
22H	PRODL	Product Register of Multiply Low Byte														
23H	INTE1	GIE	ADCIE	TMCIE				TMAIE	WDTIE	E1IE	E0IE	000_0000	000_0000	*****		
26H	INTF1			ADCIF	TMCIF				TMAIF	WDTIF	E1IF	E0IF	.00_0000	.00_0000	*****	
29H	WREG	Working Register														
2AH	BSRCN									BSR[0]00	*****			
2BH	STATUS					C	DC	N	OV	Zx xxxxu uuuu	*****			
2CH	PSTATUS	PD	TO	IDLEB	BOR						SKERR	000d_0	uduu_d	rw0,rw0,rw0,rw0 - rw0,-,-		
2DH	LVDCN				LVDIF	LVDON						VLDX[3:0]	.000_0000	.000_0000	*****	
30H	PWRCN	ENVDDA	VDDAX[1:0]=11			ENACM						0xx0_....	0xx0_....	*****		
31H	MCKCN1	ADCS[2:0]		ADCS[2:0]	ADCS[2:0]	ADCS[2:0]	ADCS[2:0]	ADCS[2:0]	ADCS[2:0]	ADCS[2:0]	ADCS[2:0]	ADCS[2:0]	ADCS[2:0]	ADCS[2:0]		
32H	MCKCN2			LSCCK	HSCK	HSS[1:0]			CPUCK[1:0]			.00_0000	.00_0000	*****		
33H	MCKCN3	LCDS[2:0]				PERCK	BZS[2:0]					000_0000	000_0000	*****		
39H	ADCRH	ADC conversion memory HighByte														
3AH	ADCRM	ADC conversion memory Middle Byte														
3BH	ADCRL	ADC conversion memory Low Byte														
3CH	ADCCN1	ENADC			ENCHP	PGAGN[1:0]			ADGN[2:0]			0.00_0000	0.00_0000	*****		
3DH	ADCCN2			INBUF=0	VRBUF=0	VREGN			DCSET[2:0]			.xx_0000	.xx_0000	*****		
3EH	ADCCN3	OSR[2:0]						OSR[3]			000_..0	000_..0	*****			
3FH	AINET1	INH[2:0]=XX0 or XX1(AI2 or AI0)				INL[2:0]=0XX or 1XX(AI1 or VSS)				INIS			xx00_xx0x	xx00_xx0x	*****	
40H	AINET2	VRH[1:0]=X0 or X1(AI2 or ACM)				INX[1:0]		VRL[1:0]=11(VSS)					xx00_xx0x	xx00_xx0x	*****	
41H	TMACN	ENTMA	TMACK	TMAS[1:0]			ENWDT	WDT[2:0]				0000_0000	0000_0000	***** w1,***		
42H	TMAR	TimerA data register														
46H	TMCCN	ENTMC	TMCC[1:0]		TMCS[2:0]			TMCS0[1:0]				0000_0000	0000_0000	*****		
47H	PRC	TimerC programmable register														
48H	TMCR	TimerC register														
4FH	PWMCN	ENPWM	ENPFD	PWMRL[1:0]							0000_....	0000_....	*****			
51H	PWMR	PWM MSB Byte register														
52H	LCDCN1	ENLCD	LC DPR	VLCDX[1:0]			LCDBF	LCDBI[1:0]=10				0000_0xxx	0000_0xxx	*****		
53H	LCDCN2	LCDBL	LCDMX[1:0]=11									0xxx_0xxx	0xxx_0xxx	*****		
54H	LCD0	Segment SEG2@[3:0] and SEG3@[7:4] data register of LCD														
55H	LCD1	Segment SEG4@[3:0] and SEG5@[7:4] data register of LCD														
56H	LCD2	Segment SEG6@[3:0] and SEG7@[7:4] data register of LCD														
57H	LCD3	Segment SEG8@[3:0] and SEG9@[7:4] data register of LCD														
58H	LCD4	Segment SEG10@[3:0] and SEG11@[7:4] data register of LCD														
59H	LCD5	Segment SEG12@[3:0] and SEG13@[7:4] data register of LCD														
5AH	LCD6	Segment SEG14@[3:0] and SEG15@[7:4] data register of LCD														
5BH	LCD7	Segment SEG16@[3:0] and SEG17@[7:4] data register of LCD														
5CH	LCD8	Segment SEG18@[3:0] and SEG19@[7:4] data register of LCD														
5DH	LCD9	Segment SEG20@[3:0] and SEG21@[7:4] data register of LCD														
6DH	PT1	PT1.7	PT1.6	PT1.5	PT1.4	PT1.3	PT1.2	PT1.1	PT1.0	xxxx_0xxx	xxxx_0xxx	*****				
6EH	TRISC1	TC1.7	TC1.6	TC1.5	TC1.4							0000_....	0000_....	*****		
70H	PT1PU	PU1.7	PU1.6	PU1.5	PU1.4	PU1.3	PU1.2	PU1.1	PU1.0	0000_0000	0000_0000	*****				
71H	PT1M1									INTEG1[1:0]	INTEG0[1:0]00000000	*****		
72H	PT1M2	PM1.7[0]														
74H	PT2					PT2.3	PT2.2	PT2.1	PT2.0xxxxxxxx	*****				
75H	TRISC2					TC2.3	TC2.2	TC2.1	TC2.000000000	*****				
77H	PT2PU					PU2.3	PU2.2	PU2.1	PU2.000000000	*****				
78H	PT2M1			PM2.2[1]	PM2.2[0]							.00_....	.00_....	*****		
80H ~ FFH	GPR0	General Purpose Register as 128Byte														
100H~17FH	GPR1	General Purpose Register as 128Byte														

Table 5-1(a) HY11P33 Register List

HY11P33

Embedded 18-Bit $\Sigma\Delta$ ADC 8-Bit RISC-like Mixed Signal Microcontroller



"r" no use, "w" read/write, "w" write, "r" read, "r0" only read 0, "r1" only read 1, "w0" only write 0, "w1" only write 1 "u" unimplemented bit, "x" unknown, "u" unchanged, "d" depends on condition												
Address	File Name	Bit7	Bit6	Bit5	Bit4	Bit3	Bit2	Bit1	Bit0	A-RESET	i-RESET	R/W
195H	BICTRL					VPP_HIGH		BIEWR	BIERD	1000 d000	1000 d000	- - - - *r0***
197H	BIEPTRL	0	0			BIE_ADDR[5:0]				0000 0000	0000 0000	w0,w0,*****
198H	BIEDH	BIE_DATA[15:8]								xxxx xxxx	xxxx xxxx	*****
199H	BIEDL	BIE_DATA[7:0]								xxxx xxxx	xxxx xxxx	*****

Table 5-1(b) HY11P33 Register List (Continued)

6. Electrical Characteristics

Absolute maximum ratings over operating free-air temperature (unless otherwise noted)

Voltage applied at V_{DD} to V_{SS}	-0.2 V to 4.0 V
Voltage applied to any pin	-0.2 V to $V_{DD} + 0.3$ V
Voltage applied to RST/VPP pin	-0.2 V to 6.9 V
Voltage applied to TST/PT1.3 pin	-0.2 V to $V_{DD} + 1$ V
Diode current at any device terminal	± 2 mA
Storage temperature, Tstg: (unprogrammed device)	-55°C to 150°C
(programmed device)	-40°C to 85°C
Total power dissipation.....	0.5w
Maximum output current sink by any PORT1 to PORT2 I/O pin.....	25mA

6.1 Recommended Operating Conditions

$T_A = -40^\circ\text{C} \sim 85^\circ\text{C}$, unless otherwise noted

Sym.	Parameter		Test Conditions	Min.	Typ.	Max.	unit
V_{DD}	Supply Voltage		All digital peripherals and CPU	2.2		3.6	V
			Analog peripherals	2.4		3.6	
V_{SS}	Supply Voltage			0		0	
XT	External	Watch crystal	$V_{DD} = 2.2\text{V}$, ENXT[0]=1		32.768K		Hz
	Oscillator	Ceramic resonator		XTSP[0]=0, XTHSP[0]=0			
	Frequency	Crystal		XTSP[0]=1, XTHSP[0]=0	450K	8M	
XTSP[0]=1, XTHSP[0]=0			1M	8M			

6.2 Internal RC Oscillator

$T_A = 25^\circ\text{C}, V_{DD} = 3.0\text{V}$, unless otherwise noted

Sym.	Parameter	Test Conditions	Min.	Typ.	Max.	unit
HAO	High Speed Oscillator frequency	ENHAO[0]=1	1.6	2.0	2.4	MHz
LPO	Low Power Oscillator frequency	V_{DD} supply voltage be enable LPO	22	28	35	KHz

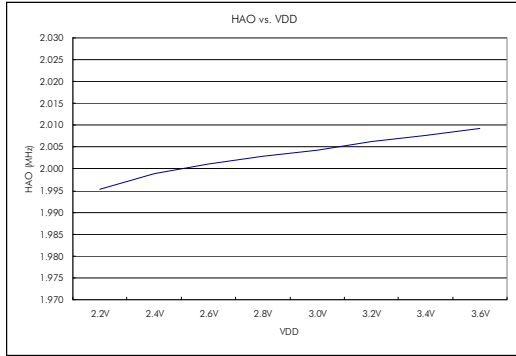

Figure 6.2-1 HAO vs. VDD

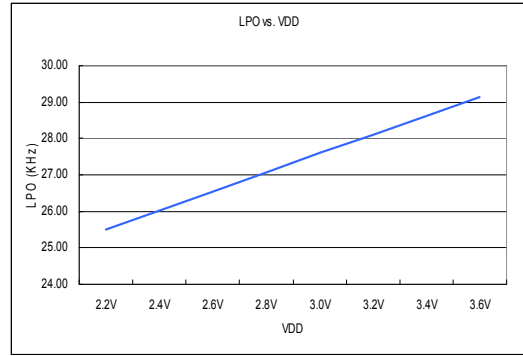

Figure 6.2-2 LPO vs. VDD

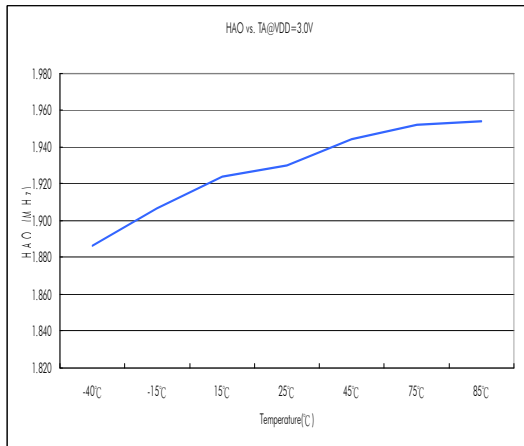

Figure 6.2-3 HAO vs. Temperature

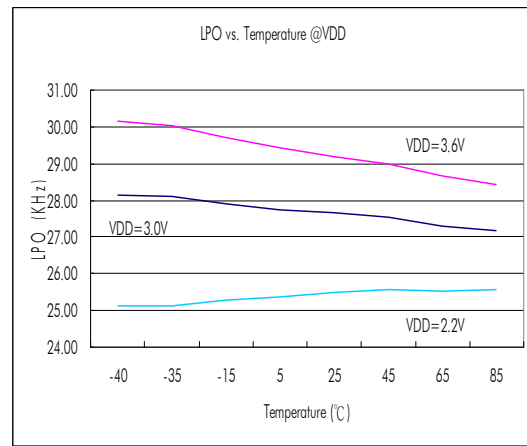

Figure 6.2-4 LPO vs. Temperature

6.3 Supply Current into VDD excluding Peripherals Current

$T_A = 25^\circ\text{C}, V_{DD} = 3.0\text{V}, \text{OSC_LPO} = 28\text{KHz}$, unless otherwise noted

Sym.	Parameter	Test Conditions	Min.	Typ.	Max.	unit
I_{AM1}	Active mode 1	OSC_CY = 8MHz, OSC_HAO = off, CPU_CK = 8MHz		1.2	2	mA
I_{AM2}	Active mode 2	OSC_CY = off, OSC_HAO = 2MHz, CPU_CK = 2MHz		0.32	0.55	mA
I_{AM3}	Active mode 3	OSC_CY = off, OSC_HAO = 2MHz, CPU_CK = 1MHz		0.18	0.3	mA
I_{LP1}	Low Power 1	OSC_CY = 32768Hz, OSC_HAO = off, CPU_CK = 16384Hz		7	12	μA
I_{LP2}	Low Power 2	OSC_CY = off, OSC_HAO = off, CPU_CK = LPO, Idle state		1.65	3	μA
I_{LP3}	Low Power 3	OSC_CY = off, OSC_HAO = off, CPU_CK = off, Sleep state		0.65	1.2	μA

OSC_CY : External Oscillator frequency.

OSC_HAO : Internal High Accuracy Oscillator frequency.

CPU_CK : CPU core work frequency.

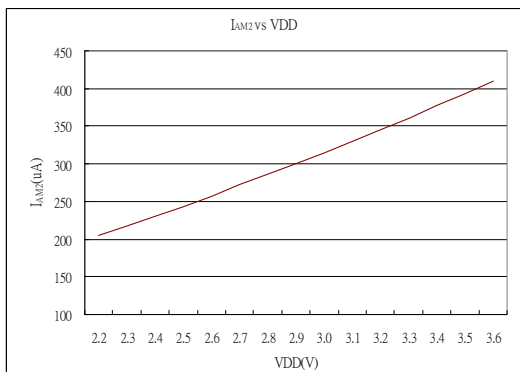

Figure 6.3-1 I_{AM2} vs. VDD

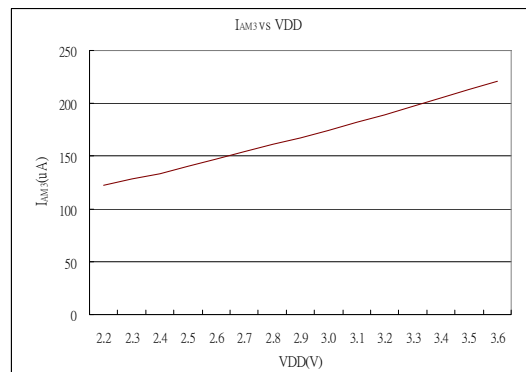

Figure 6.3-2 I_{AM3} vs. VDD

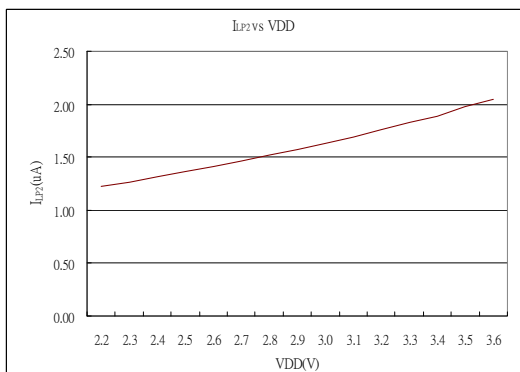

Figure 6.3-3 I_{LP2} vs. VDD

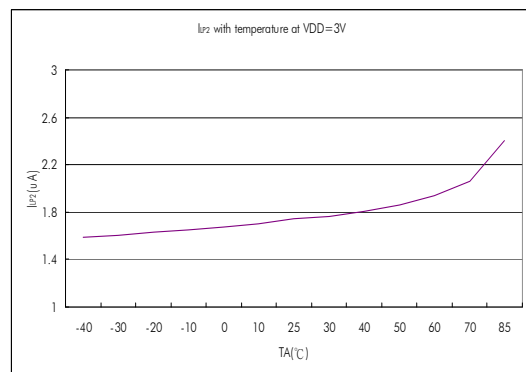

Figure 6.3-4 I_{LP2} vs. Temperature

HY11P33

Embedded 18-Bit $\Sigma\Delta$ ADC

8-Bit RISC-like Mixed Signal Microcontroller

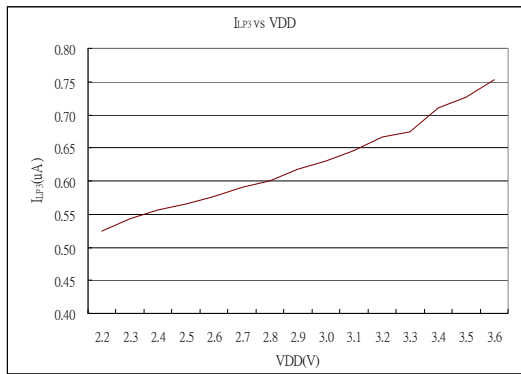

Figure 6.3-5 I_{LP3} vs. VDD

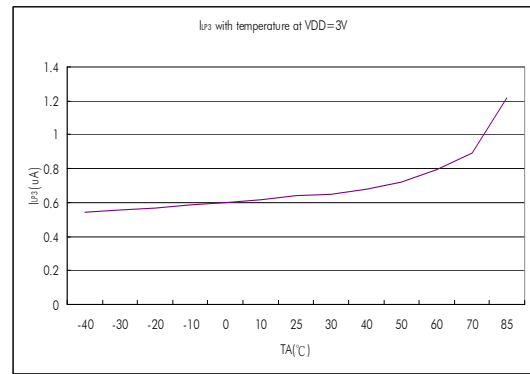

Figure 6.3-6 I_{LP3} vs. Temperature

6.4 Port1~2

$T_A = 25^\circ\text{C}, V_{DD} = 3.0\text{V}$, unless otherwise noted

Sym.	Parameter	Test Conditions	Min.	Typ.	Max.	unit
Input voltage and Schmitt trigger and leakage current and timing						
V_{IH}	High-Level input voltage				2.1	V
V_{IL}	Low-Level input voltage		0.9			
V_{hys}	Input Voltage hysteresis($V_{IH} - V_{IL}$)			0.8		V
I_{LKG}	Leakage Current				0.1	uA
R_{PU}	Port pull high resistance			180		kΩ
Output voltage and current and frequency						
V_{OH}	High-level output voltage	$I_{OH}=10\text{mA}$	$V_{DD}-0.3$			V
V_{OL}	Low-level output voltage	$I_{OL}=-10\text{mA}$			$V_{SS}+0.3$	

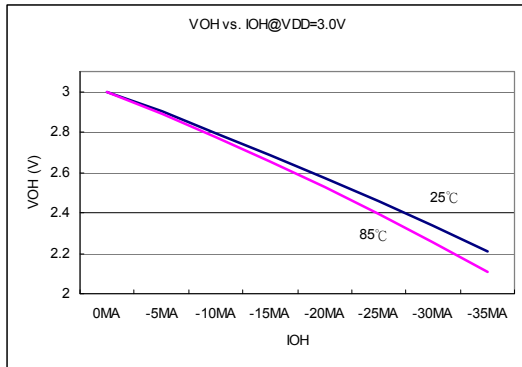

Figure 6.4-1 V_{OH} vs. I_{OH} @ $V_{DD}=3.0\text{V}$

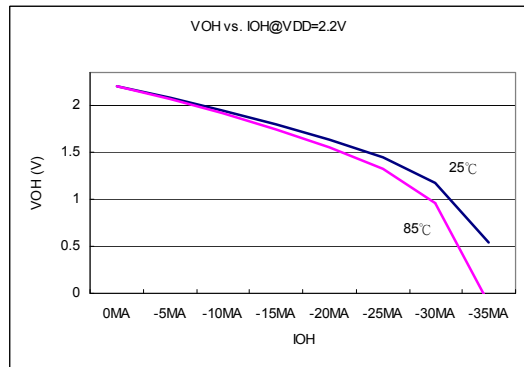

Figure 6.4-2 V_{OH} vs. I_{OH} @ $V_{DD}=2.2\text{V}$



Figure 6.4-3 V_{OL} vs. I_{OL} @ $V_{DD}=3.0\text{V}$

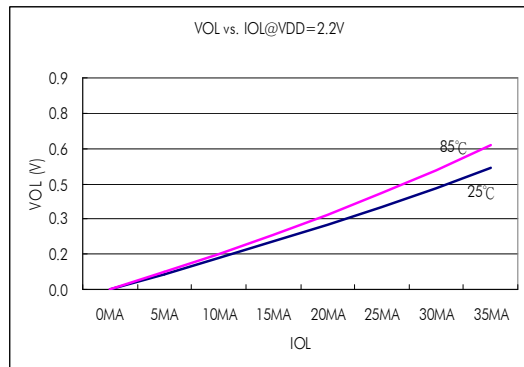

Figure 6.4-4 V_{OL} vs. I_{OL} @ $V_{DD}=2.2\text{V}$

6.5 Reset(Brownout, External RST pin, Low Voltage Detect)

$T_A = 25^\circ\text{C}, V_{DD} = 3.0\text{V}$, unless otherwise noted

Sym.	Parameter	Test Conditions	Min.	Typ.	Max.	unit	
BOR	Pulse length needed to accepted reset internally, t_{d-LVR}		2			us	
	V_{DD} Start Voltage to accepted reset internally (L→H), V_{LVR}		1.6	1.85	2.1	V	
	Hysteresis, $V_{HYS-LVR}$			70		mV	
RST	Pulse length needed as RST/VPP pin to accepted reset internally, t_{d-RST}		2			us	
	Input Voltage to accepted reset internally		0.9			V	
	Hysteresis, $V_{HYS-RST}$			0.8		V	
LVD	Operation current, I_{LVD}			10	15	uA	
	External input voltage to compare reference voltage			1.2		V	
	Compare reference voltage temperature drift	$T_A = -40^\circ\text{C} \sim 85^\circ\text{C}$		100		ppm/ $^\circ\text{C}$	
	Detect V_{DD} voltage rang by user option, $V_{SVS} VLDx[3:0]=1110b$			3.3		V	
	Detect V_{DD} voltage rang by user option, $V_{SVS} VLDx[3:0]=1101b$			3.2			
	Detect V_{DD} voltage rang by user option, $V_{SVS} VLDx[3:0]=1100b$			3.1			
	Detect V_{DD} voltage rang by user option, $V_{SVS} VLDx[3:0]=1011b$			3.0			
	Detect V_{DD} voltage rang by user option, $V_{SVS} VLDx[3:0]=1010b$			2.9			
	Detect V_{DD} voltage rang by user option, $V_{SVS} VLDx[3:0]=1001b$			2.8			
	Detect V_{DD} voltage rang by user option, $V_{SVS} VLDx[3:0]=1000b$			2.7			
	Detect V_{DD} voltage rang by user option, $V_{SVS} VLDx[3:0]=0111b$			2.6			
	Detect V_{DD} voltage rang by user option, $V_{SVS} VLDx[3:0]=0110b$			2.5			
	Detect V_{DD} voltage rang by user option, $V_{SVS} VLDx[3:0]=0101b$			2.4			
	Detect V_{DD} voltage rang by user option, $V_{SVS} VLDx[3:0]=0100b$			2.3			
	Detect V_{DD} voltage rang by user option, $V_{SVS} VLDx[3:0]=0011b$			2.2			
	Detect V_{DD} voltage rang by user option, $V_{SVS} VLDx[3:0]=0010b$			2.1			
	Detect V_{DD} voltage rang by user option, $V_{SVS} VLDx[3:0]=0001b$			2.0			
BOR : Brownout Reset LVR : Low Voltage Reset of BOR LVD : Low Voltage Detect RST : External Reset pin							

HY11P33

Embedded 18-Bit $\Sigma\Delta$ ADC
8-Bit RISC-like Mixed Signal Microcontroller

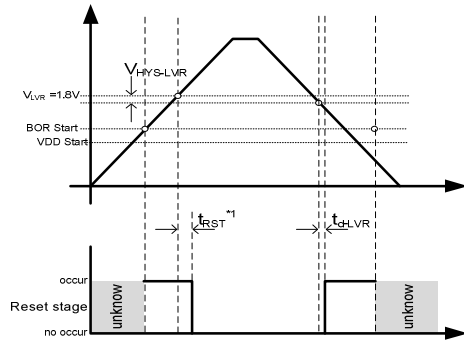

Figure 6.5-1 BOR Reset diagram

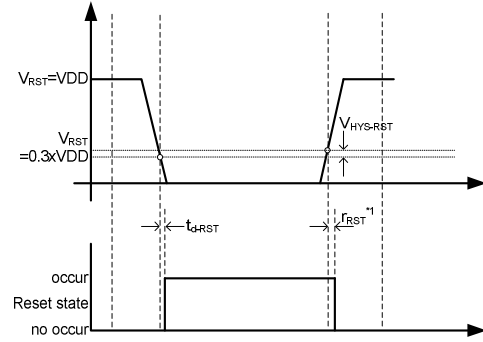

Figure 6.5-2 RST Reset diagram

*1 t_{RST} : Please see BOR Introduce of HY11Pxx series User's Guide (UG-HY11S14-Vxx).

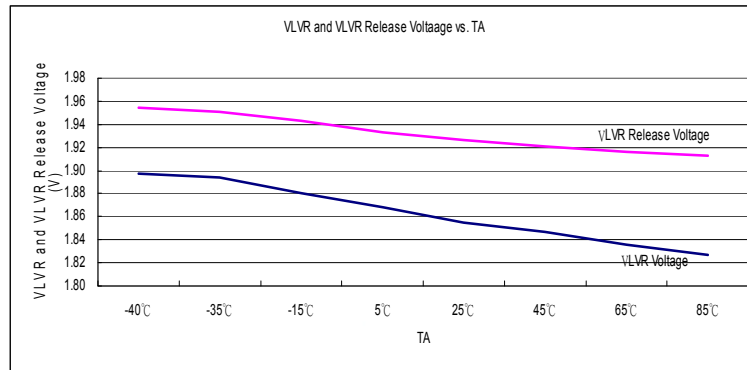

Figure 6.5-3 LVR vs. Temperature

6.6 Power System

$T_A = 25^\circ\text{C}, V_{DD} = 3.0\text{V}$, unless otherwise noted

Sym.	Parameter	Test Conditions		Min.	Typ.	Max.	unit
VDDA	VDDA operation current, I_{VDDA}	$I_L = 0\text{mA}$	VDDAX[1:0]=00b	22			μA
	Select VDDA output voltage	$I_L = 0.1\text{mA}$, $V_{DD} \geq V_{DDA} + 0.25\text{V}$	VDDAX [1:0]=11b	2.4			V
	Dropout voltage	$I_L = 10\text{mA}$	VDDAX [1:0]=11b	250			mV
	Temperature drift	VDDAX [1:0]=11b	$T_A = -40^\circ\text{C} \sim 85^\circ\text{C}$	50			ppm/ $^\circ\text{C}$
	V_{DD} Voltage drift	$I_L = 0.1\text{mA}$	$V_{DD} = 2.5\text{V} \sim 3.6\text{V}$	± 0.2			%/V
ACM	ACM operation current, I_{ACM}	$I_L = 0\text{mA}$		20			μA
	Output voltage, V_{ACM}	ENACM[0]=1	$I_L = 0\mu\text{A}$	1.0			V
	Output voltage with Load		$I_L = \pm 200\mu\text{A}$	0.98	1.02		V_{ACM}
	Temperature drift	ENACM[0]=1,	$T_A = -40^\circ\text{C} \sim 85^\circ\text{C}$	50			ppm/ $^\circ\text{C}$
	VDDA Voltage drift	$I_L = 10\mu\text{A}$		100			$\mu\text{V}/\text{V}$

VDDA : Adjust Voltage Regulator
ACM : Analog Common Mode Voltage

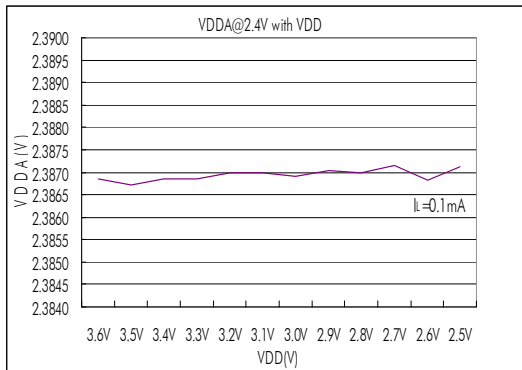

Figure 6.6-1 VDDA $I_L=0.1\text{mA}$ vs. VDD

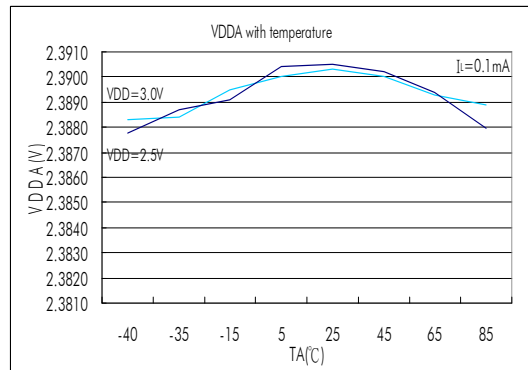

Figure 6.6-2 VDDA $I_L=0.1\text{mA}$ vs. Temperature

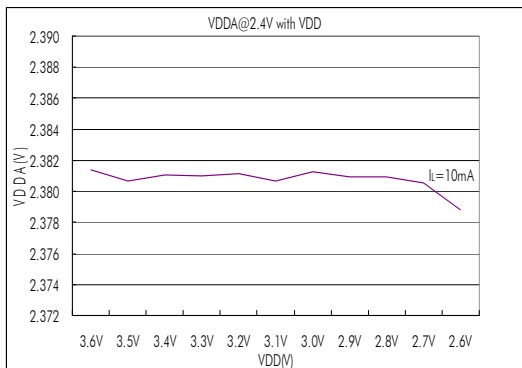

Figure 6.6-3 VDDA $I_L=10\text{mA}$ vs. VDD

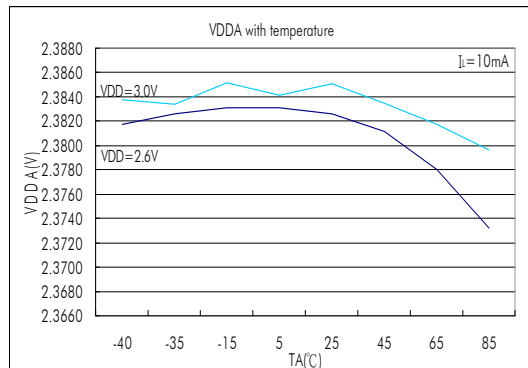

Figure 6.6-4 VDDA $I_L=10\text{mA}$ vs. Temperature

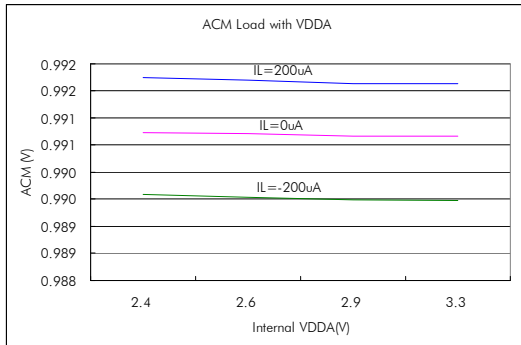

Figure 6.6-5 ACM Load vs. VDDA

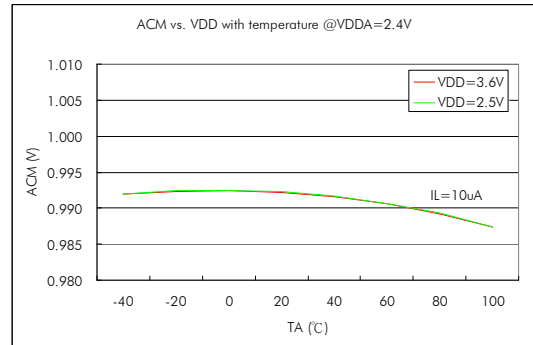

Figure 6.6-6 ACM vs. Temperature

6.7 LCD

$T_A = 25^\circ\text{C}$, $V_{DD} = 3.0\text{V}$, $C_{VLCD} = 4.7\mu\text{F}$, unless otherwise noted.

Sym.	Parameter	Test Conditions		Min.	Typ.	Max.	unit
I_{LCD}	Operation supply current without output buffer.(all segment turn on)	LCDPR[0]=1	$V_{DD} = 2.2\text{V}$	10			μA
			$V_{DD} = 3.0\text{V}$				
VLCD	Supply Voltage at VLCD pin	LCDPR[0]=0		2.2		3.6	V
	Embedded Charge Pump output voltage at VLCD pin	LCDPR[0]=1, $C_{VLCD} = 4.7\mu\text{F}$	VLCDX[1:0]=11b	2.295	2.55	2.805	V
			VLCDX[1:0]=10b	2.52	2.8	3.08	
			VLCDX[1:0]=01b	2.745	3.05	3.355	
			VLCDX[1:0]=00b	2.97	3.3	3.63	
Z_{LCD}	Output impedance with LCD buffer	$f_{LCD} = 128\text{Hz}$, VLCD=3.05V		10		$\text{k}\Omega$	

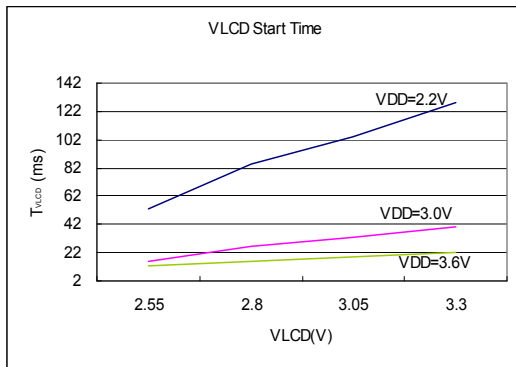

Figure 6.7-1 LCD Start Time

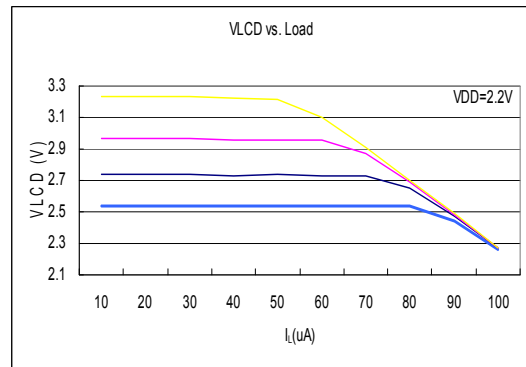

Figure 6.7-2 VLCD vs. I_L @ VDD=2.2V

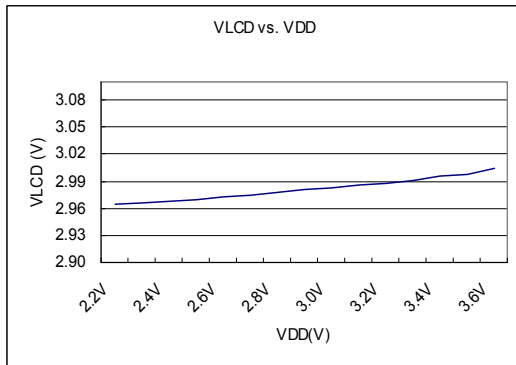

Figure 6.7-3 VLCD vs. VDD

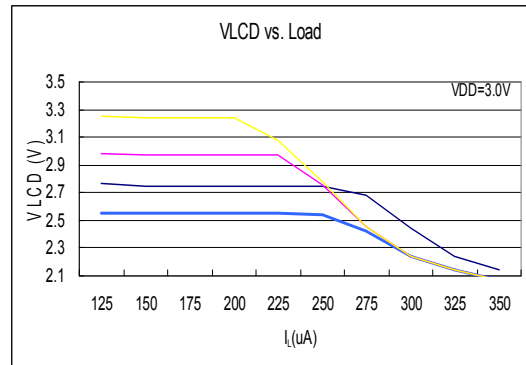

Figure 6.7-4 VLCD vs. I_L @ VDD=3.0V

6.8 SD18, Power Supply and Recommended Operating Conditions

$T_A = 25^\circ\text{C}, V_{DD} = 3.0\text{V}, V_{DDA}=2.4\text{V}$, unless otherwise noted

Sym.	Parameter	Test Conditions		Min.	Typ.	Max.	unit
V_{SD18}	Supply Voltage at VDDA	ENVDDA[0]=0		2.4		3.6	V
f_{SD18}	Modulator sample frequency, ADC_CK			25	250	300	KHz
	Over Sample Ratio, OSR			128 ^{*1}		32768	
I_{SD18}	Operation supply current without PGA	ENADC[0]=1 INBUF[0]=0,VRBUF[0]=0	GAIN =4, ADC_CK=250KHz		120		μA

*1, OSR=128, setting by ADCCN3[OSR3] bit.
OSR[3:0]=1010b, OSR=128; OSR[3:0]=0xxx, OSR=256 ~ 32768
OSR[3:0]=1xxxb can't set by user

6.8.1 PGA, Power Supply and Recommended Operating Conditions

$T_A = 25^\circ\text{C}, V_{DD} = 3.0\text{V}, V_{DDA}=2.4\text{V}$, unless otherwise noted

Sym.	Parameter	Test Conditions		Min.	Typ.	Max.	unit
V_{PGA}	Supply Voltage at VDDA	ENVDDA[0]=0		2.4		3.6	V
I_{PGA}	Operation supply current	PGAGN[1:0]=<11>			320		μA
G_{PGA}	Gain temperature drift	$T_A = -40^\circ\text{C} \sim 85^\circ\text{C}$	GAIN=128		15		ppm/ $^\circ\text{C}$

6.8.2 SD18, Performance II ($f_{SD18}=250\text{KHz}$)

$T_A = 25^\circ\text{C}, V_{DD} = 3.0\text{V}, V_{DDA}=2.9\text{V}, V_{VR}=1.0\text{V}, \text{GAIN}=1$ without PGA, unless otherwise noted

Sym.	Parameter	Test Conditions		Min.	Typ.	Max.	unit
INL	Integral Nonlinearity(INL)	$V_{DDA}=2.4\text{V}, V_{VR}=1.0\text{V}, \Delta\text{SI}=\pm 200\text{mV}$			± 0.003	± 0.01	%FSR
		$V_{DDA}=2.4\text{V}, V_{VR}=1.0\text{V}, \Delta\text{SI}=\pm 450\text{mV}$					
	No Missing Codes ³	ADC_CK=250KHz, OSR[2:0]=010b		19			Bits
G_{SD18}	Temperature drift Gain 1~x16 (INBUF[0]=0b,)	INBUF[0]=0b,VRBUF[0]=0b	$T_A = -40^\circ\text{C} \sim 85^\circ\text{C}$		10		ppm/ $^\circ\text{C}$
E_{OS}	Offset error of Full Scale Rang input voltage range with Chopper without PGA	$\Delta\text{AI}=0\text{V}$ $\Delta\text{VR}=0.9\text{V}$	Gain=2			1	%FSR
	Offset error temperature drift with chopper without PGA	DCSET[2:0]=<000> * ΔAI is external short	GAIN=1		2		$\mu\text{V}/^\circ\text{C}$
			GAIN=2		1		
			GAIN=4		0.5		
		GAIN=16		0.15			

HY11P33

Embedded 18-Bit $\Sigma\Delta$ ADC 8-Bit RISC-like Mixed Signal Microcontroller

$T_A = 25^\circ\text{C}, V_{DD} = 3.0\text{V}, V_{DDA}=2.9\text{V}, V_{VR}=1.0\text{V}, \text{GAIN}=1$ without PGA, unless otherwise noted

Sym.	Parameter	Test Conditions	Min.	Typ.	Max.	unit
CM _{SD18}	Common-mode rejection	$V_{CM}=0.7\text{V}$ to 1.7V , $V_{VR}=1.0\text{V}$, without PGA	$V_{SI}=0\text{V}$, GAIN=1		90	dB
		$V_{CM}=0.7\text{V}$ to 1.7V , $V_{VR}=1.0\text{V}$, without PGA	$V_{SI}=0\text{V}$, GAIN=16		75	
PSRR	DC power supply rejection	$V_{DDA}=3.0\text{V}, \Delta V_{DDA}=\pm 100\text{mV}$, $V_{VR}=1.0\text{V}, V_{SI}=1.2\text{V}, V_{SIL}=1.2\text{V}$,	GAIN=1	75		dB
			PGA=off			
			GAIN=16 PGA=8			

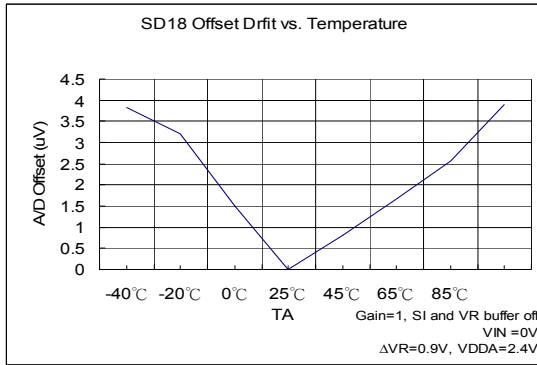

Figure 6.8-1(a) SD18 Offset Temperature Drift

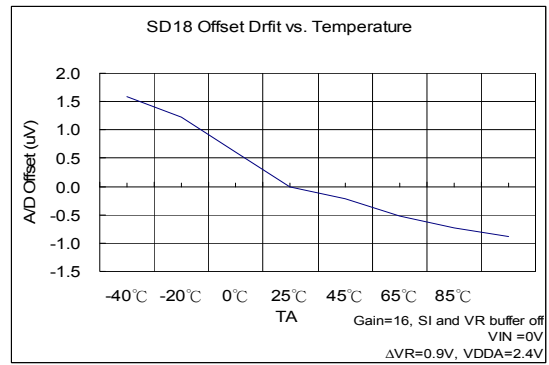

Figure 6.8-1(b) SD18 Offset Temperature Drift

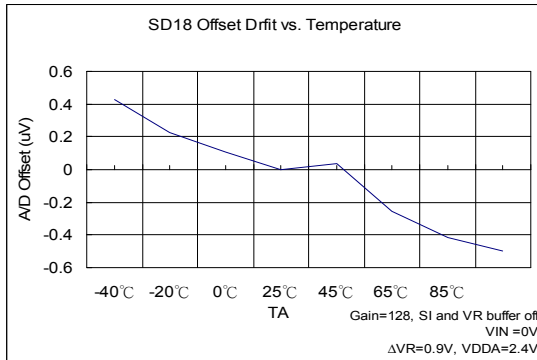

Figure 6.8-1(c) SD18 Offset Temperature Drift

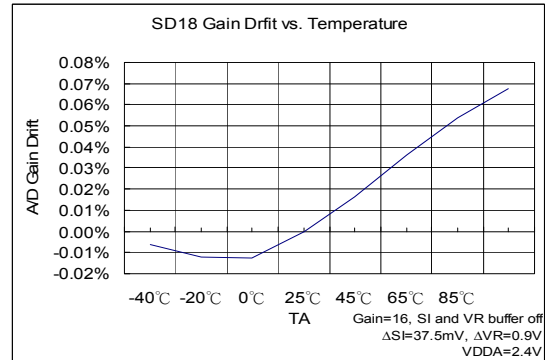

Figure 6.8-2(a) SD18 Gain Drift with Temperature

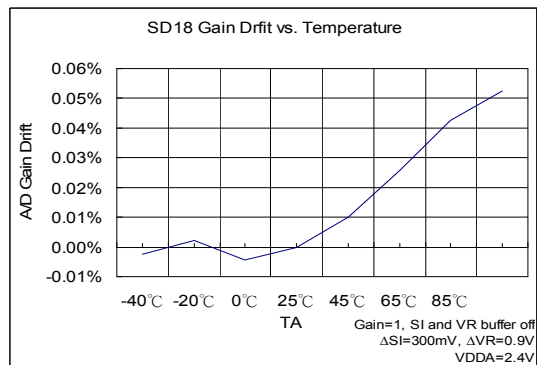

Figure 6.8-2(b) SD18 Gain Drift with Temperature

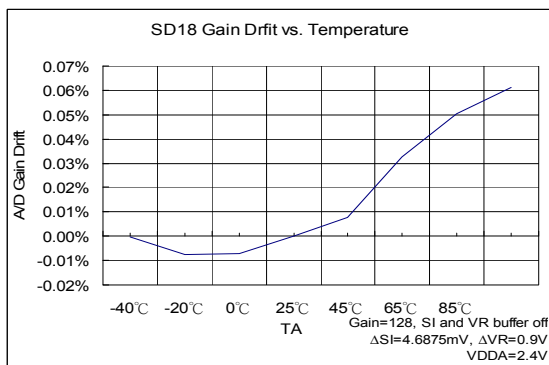

Figure 6.8-2(c) SD18 Gain Drift with Temperature

6.8.3 SD18 Noise Performance

$T_A = 25^\circ\text{C}$, $V_{DD} = 3.0\text{V}$, $V_{DDA} = 2.4\text{V}$, unless otherwise noted

HY11P33 provides important input noise specification that aims at SD18. Table 6.8-3(a) and Table 6.8-3(b) lists out the relations of typical noise specification, Gain, Output rate, and maximum input voltage of single end. Test condition configuration and external input signal short, voltage reference: 1.2V and 1024 records were sampled.

ENOB(RMS) with OSR/GAIN at A/D Clock=250Khz, VDDA=2.4V, VREF=1.2V														
Max. Vin(mV) =0.9*VREF ⁽¹⁾	OSR				128	256	512	1024	2048	4096	8192	16384	32768	
	Output rate(HZ)				1953	977	488	244	122	61	31	15	8	
	Gain	=	PGA	x	ADGN									
± 2400	0.25	=	1	x	0.25	14.43	16.07	17.20	17.86	18.29	18.66	18.98	19.13	19.30
± 2160	0.5	=	1	x	0.5	14.34	16.05	17.13	17.84	18.26	18.62	18.90	19.13	19.27
± 1080	1	=	1	x	1	14.38	16.06	17.11	17.72	18.13	18.53	18.88	19.05	19.22
± 540	2	=	1	x	2	14.40	15.98	16.96	17.59	18.01	18.45	18.79	19.01	19.17
± 270	4	=	1	x	4	14.39	15.88	16.82	17.39	17.85	18.28	18.65	18.95	19.13
± 135	8	=	1	x	8	14.27	15.75	16.58	17.15	17.60	18.04	18.45	18.78	19.02
± 68	16	=	1	x	16	14.14	15.51	16.18	16.73	17.21	17.70	18.15	18.52	18.83
± 8	128	=	8	x	16	13.04	13.83	14.32	14.87	15.38	15.86	16.36	16.84	17.28

(1) Max.Vin (mV) is the max. input voltage of single end to ground (VSS).

Table 6.8-3(a) SD18 ENOB Table

RMS Noise(uV) with OSR/GAIN at A/D Clock=250Khz, VDDA=2.4V, VREF=1.2V														
Max. Vin(mV) =0.9*VREF	OSR				128	256	512	1024	2048	4096	8192	16384	32768	
	Output rate(HZ)				1953	977	488	244	122	61	31	15	8	
	Gain	=	PGA	x	ADGN									
± 2400	0.25	=	1	x	0.25	362.92	139.77	64.33	40.65	30.04	23.35	18.70	16.75	14.92
± 2160	0.5	=	1	x	0.5	193.22	70.82	33.83	20.60	15.37	12.00	9.86	8.38	7.61
± 1080	1	=	1	x	1	94.14	35.38	17.16	11.17	8.40	6.34	5.01	4.44	3.92
± 540	2	=	1	x	2	46.23	18.59	9.48	6.13	4.57	3.35	2.66	2.28	2.05
± 270	4	=	1	x	4	23.37	9.98	5.20	3.51	2.54	1.89	1.46	1.18	1.05
± 135	8	=	1	x	8	12.66	5.47	3.06	2.06	1.51	1.11	0.84	0.67	0.56
± 68	16	=	1	x	16	6.93	3.23	2.02	1.38	0.99	0.70	0.51	0.40	0.32
± 8	128	=	8	x	16	1.86	1.29	0.91	0.63	0.44	0.32	0.22	0.16	0.12

Table 6.8-3(b) SD18 RMS Noise Table

The RMS noise are referred to the input. The Effective Number of Bits (ENOB(RMS Bit)) is defined as:

$$\text{ENOB(RMS)} = \frac{\ln\left(\frac{\text{FSR}}{\text{RMS Noise}}\right)}{\ln(2)}$$

$$\text{RMS Noise} = \frac{\left(2 \times \text{VREF} \times \sqrt{\sum_{k=1}^{1024} (\text{ADO}[k] - \text{Average})^2}\right)}{2^{23}}$$

Where FSR (Full - Scale Range) = $2 \times \text{VREF}/\text{Gain}$.

$$\text{Average} = \frac{\sum_{k=1}^{1024} (\text{ADO}[k])}{1024}$$

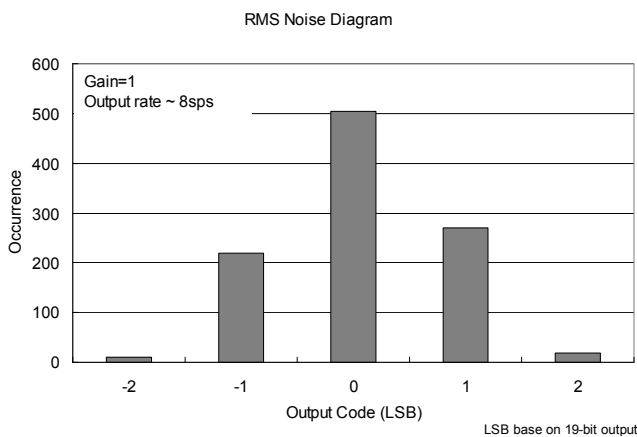

Figure 6.8-3(a) RMS Noise Diagram

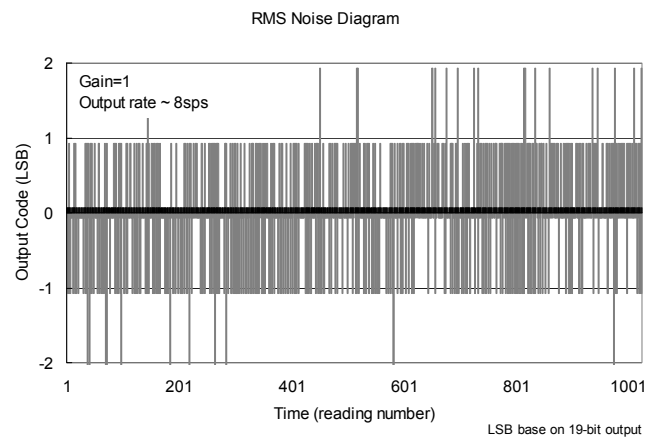

Figure 6.8-3(b) Output Code Diagram

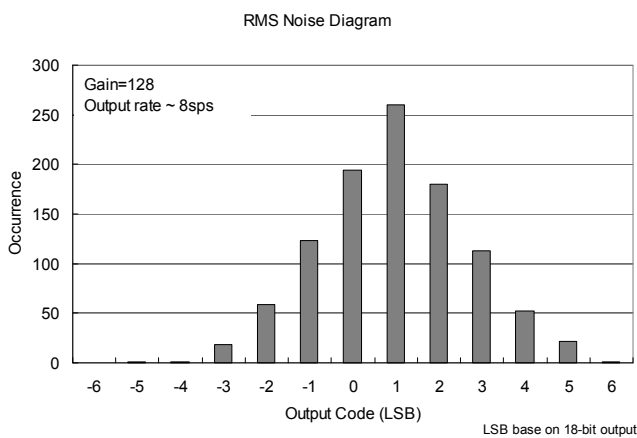

Figure 6.8-3(c) RMS Noise Diagram

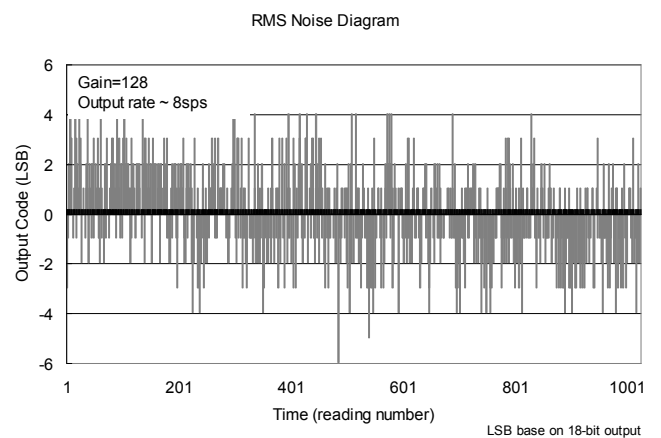

Figure 6.8-3(d) Output Code Diagram

6.9 Built-In EPROM (BIE)

$T_A = 25^\circ\text{C}$, $V_{DD} = 3.0\text{V}$, unless otherwise noted

Sym.	Parameter	Test Conditions	Min.	Typ.	Max.	unit
V_{BIE}	Supply Voltage			6.0	6.5	V
I_{BIE}	Operation supply current			5		mA
V_{SS}	Supply Voltage			0		V

7. Ordering Information

Device No. ¹	Package Type	Pins	Package Drawing		Code ²	Shipment Packing Type	Unit Q'ty	Material Composition	MSL ³
			D	000					
HY11P33-D000	Die	-	D	000	000	-	200	Green ⁴	-
HY11P33-L064	LQFP	64	L	064	000	Tray	250	Green ⁴	MSL-3

¹ **Device No.:** Model No. – Package Type Description – Code (Blank Code/ Standard/ Customized Programming Code)

Ex: You request blank code in die package and the model No. is HY11P33.

The device No. will be HY11P33-D000.

Ex: Your customized programming code is 008, the model No. is HY11P33 and you require die shipment. The device No. will be HY11P33-D000-008.

Ex: You request blank code in LQFP 64 package and the model No. is HY11P33.

The device No. will be HY11P33-L064.

And please clearly indicate the shipment packing type when placing orders.

Ex: Your customized programming code is 009, the model No. is HY11P33 and you require products in LQFP 64 package.

The device No. will be HY11P33-L064-009.

And please clearly indicate the shipment packing type when placing orders.

² **Code:**

“001”~ “999” is standard or customized programming code. Blank code does not have these numbers.

³ **MSL:**

The Moisture Sensitivity Level ranking conforms to IPC/JEDEC J-STD-020 industry standard categorization. The products are processed, packed, transported and used with reference to IPC/JEDEC J-STD-033.

⁴ **Green (RoHS & no Cl/Br):**

HYCON products are Green products that compliant with RoHS directive and are Halogen free (Br/Cl<0.1%

HY11P33

Embedded 18-Bit $\Sigma\Delta$ ADC
8-Bit RISC-like Mixed Signal Microcontroller

8. Package Information

8.1 LQFP64(L064)

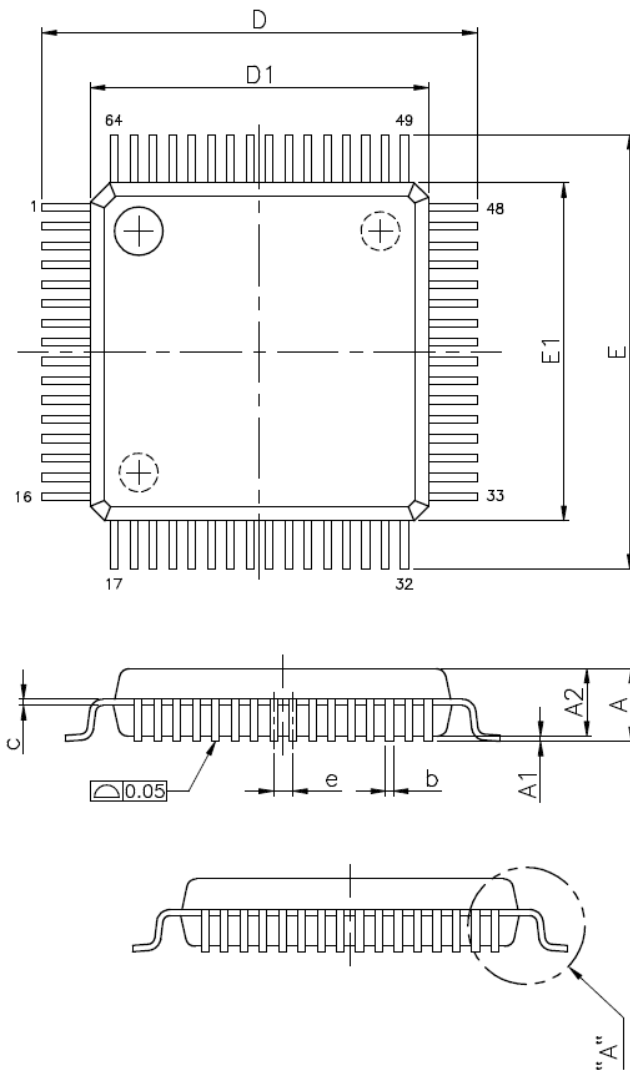

VARIATIONS (ALL DIMENSIONS SHOWN IN MM)

SYMBOLS	MIN.	NOM.	MAX.
A	—	—	1.60
A1	0.05	—	0.15
A2	1.35	1.40	1.45
b	0.13	0.18	0.23
c	0.09	—	0.20
D	9.00 BSC		
D1	7.00 BSC		
e	0.40 BSC		
E	9.00 BSC		
E1	7.00 BSC		
L	0.45	0.60	0.75
L1	1.00 REF		
θ	0°	3.5°	7°

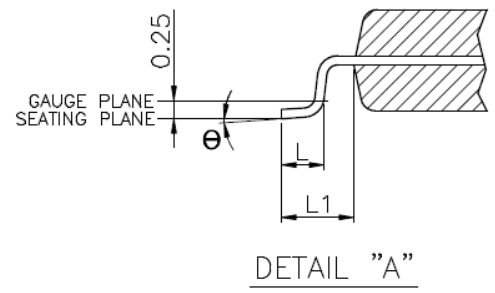

JEDEC MS-026 compliant

9. Revision Record

Major differences are stated thereafter:

Version	Page	Revision Summary
V01	ALL	First Edition
V02	ALL	Entire content revision
V04	5	Revise product features
	12	Revise SD18 Network