



HY11P14

Datasheet

**8-Bit RISC-like Mixed Signal Microcontroller
Embedded 4x40 LCD Driver
Low Noise Amplifier
18-Bit Σ ADC**

目錄

1. 特點	5
2. 引腳定義	6
2.1 LQFP100 引腳圖	6
2.2 LQFP64 引腳圖	7
2.3 I/O 引腳定義	8
3. 應用電路	13
3.1 橋式感測器	13
4. 功能概述	14
4.1 內部方塊圖	14
4.2 相關說明與支援文件	14
4.3 SD18 Network	15
4.4 Low Noise OPAMP Network	16
4.5 Enhance Comparator Network	17
5. 暫存器列表	18
6. 電氣特性	20
6.1 Recommended operating conditions	20
6.2 Internal RC Oscillator	21
6.3 Supply current into VDD excluding peripherals current	22
6.4 Port1~5	24
6.5 Reset(Brownout, External RST pin, Low Voltage Detect)	25
6.6 Power System	27
6.7 LCD	29

HY11P14

Embedded 18-Bit $\Sigma\Delta$ ADC

8-Bit RISC-like Mixed Signal Microcontroller



6.8	Low Noise OPAMP	30
6.9	SD18,Power Supply and recommended operating conditions	31
6.10	PGA,Power Supply and recommended operating conditions	31
6.11	SD18,performance II (fSD18=250KHz).....	31
6.12	SD18,Temperature sensor	34
6.13	SD18 Noise Performance	35
7.	訂貨資訊	37
8.	封裝型式資訊.....	38
8.1	LQFP100(L100 10x10).....	38
8.2	LQFP64(L064 7x7).....	39
9.	修訂記錄	40

注意：

- 1、本說明書中的內容，隨著產品的改進，有可能不經過預告而更改。請客戶及時到本公司網站下載更新
<http://www.hycontek.com>
- 2、本規格書中的圖形、應用電路等，因第三方工業所有權引發的問題，本公司不承擔其責任。
- 3、本產品在單獨應用的情況下，本公司保證它的性能、典型應用和功能符合說明書中的條件。當使用在客戶的產品或設備中，以上條件我們不作保證，建議客戶做充分的評估和測試。
- 4、請注意輸入電壓、輸出電壓、負載電流的使用條件，使 IC 內的功耗不超過封裝的容許功耗。對於客戶在超出說明書中規定額定值使用產品，即使是瞬間的使用，由此所造成的損失，本公司不承擔任何責任。
- 5、本產品雖內置防靜電保護電路，但請不要施加超過保護電路性能的過大靜電。
- 6、本規格書中的產品，未經書面許可，不可使用在要求高可靠性的電路中。例如健康醫療器械、防災器械、車輛器械、車載器械及航空器械等對人體產生影響的器械或裝置，不得作為其部件使用。
- 7、本公司一直致力於提高產品的品質和可靠度，但所有的半導體產品都有一定的失效概率，這些失效概率可能會導致一些人身事故、火災事故等。當設計產品時，請充分留意冗餘設計，採用安全指標，這樣可以避免事故的發生。
- 8、本規格書中內容，未經本公司許可，嚴禁用於其他目的之轉載或複製。

1. 特點

- 8 位元加強型精簡指令集，共有 66 個指令包含硬體乘法指令及查表指令
- 2.2V to 3.6V 工作電壓範圍，-40°C ~85°C 工作溫度範圍
- 外部石英震盪器及內部高精度 RC 震盪器，6 種 CPU 工作時脈切換選擇，可讓使用者達到最佳省電規劃
 - 運行模式 300uA@2MHz
 - 待機模式 3uA@32KHz
 - 休眠模式 1uA
- 8KWord OTP (One Time Programmable) Type 程式記憶體，512Byte 資料記憶體
- Brownout and Watch dog Timer，可防止 CPU 進入死機模式
- 18bit 全差動輸入 $\Sigma\Delta$ ADC 類比數位轉換器
 - 內置 PGA (Programmable Gain Amplifier) 及可有 1/4、1/2、1、.....128 倍 10 種輸入信號放大倍率選擇
 - 內置輸入零點調整，可針對不同應用增加其量測範圍
 - 內置高阻抗輸入緩衝器(4 以上輸入倍率不適用)
 - 內置絕對溫度感測器
- 超低輸入雜訊(<1uVpp)運算放大器，可提供高輸出阻抗小訊號的放大及小電流的電壓轉換
- 1.0V, 1.2V 的內部類比電路共地電壓源，具有 Push-Pull 驅動能力，可提供傳感器驅動電壓
- LVD 低電壓檢測功能具 14 段檢測電壓設置與外部輸入電壓檢測功能
- 類比電壓源 VDDA 可選擇 4 種不同輸出電壓，具 10mA 穩壓電壓源輸出能力
- 4x40 LCD 液晶驅動器
 - Static、1/2、1/3、1/4 Duty 及 1/3 Bias 軟體選擇
 - 內建 Charge Pump 穩壓線路，提供 4 種 LCD 偏壓
- 增強型比較器
 - 兩組電壓源產生器
 - 具 0.25 倍或 0.5 倍工作電壓比較與自動轉態功能及 15 段比較電壓設置
 - 內置溫度感測電路
- 8-bit Timer A
- 16-bit Timer B 模組具 Capture/Compare 功能
- 8-bit Timer C 模組具 PWM/PFD 波形產生功能
- 串列通訊 SPI、EUART 模組
- Support 8 stack level

HY11P14

Embedded 18-Bit Σ ADC

8-Bit RISC-like Mixed Signal Microcontroller



2. 引腳定義

2.1 LQFP100 引腳圖



圖 2-1 HY11P14 LQFP100 引腳圖

2.2 LQFP64 引腳圖

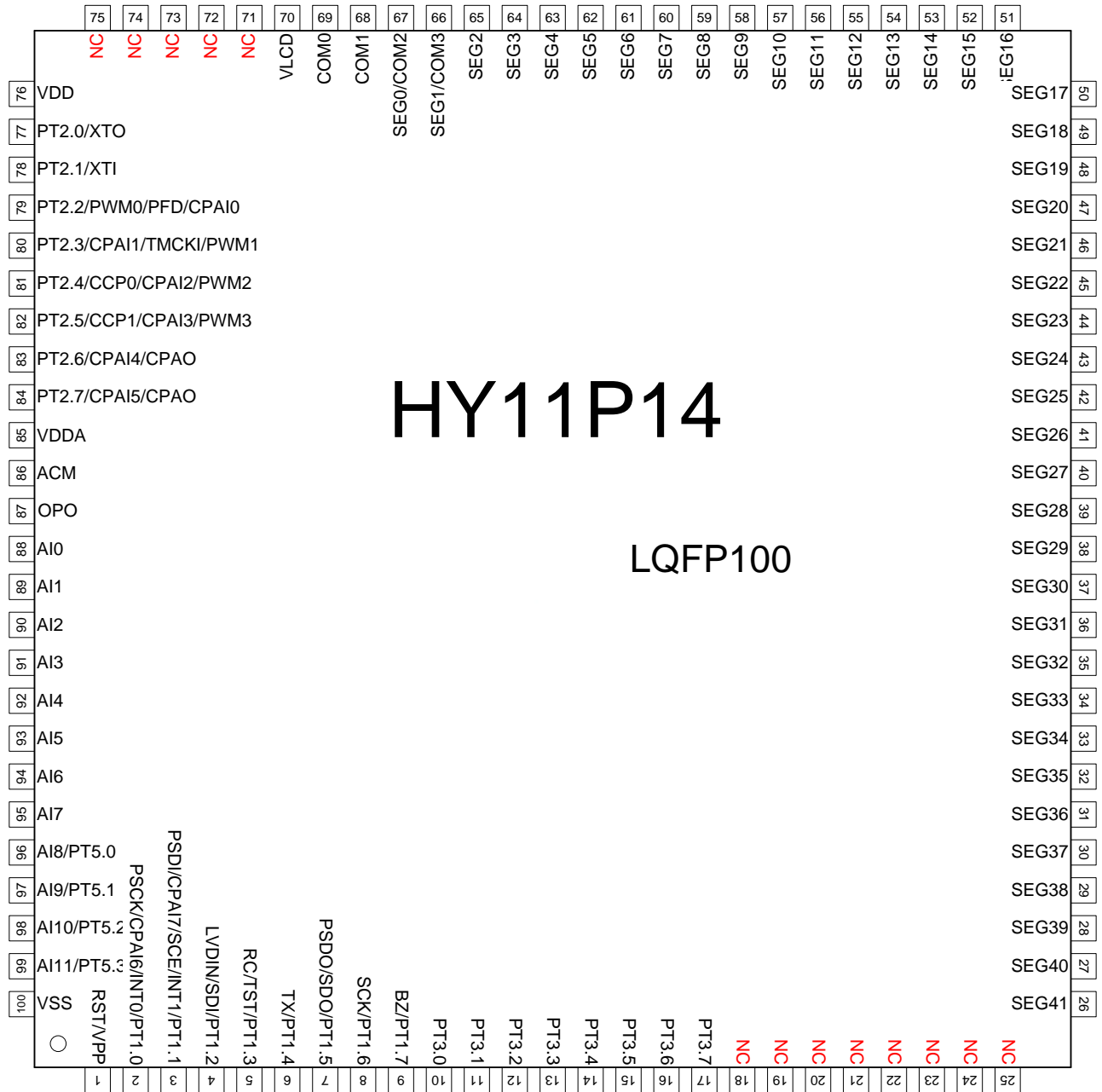

圖 2-2 HY11P14 LQFP64 引腳圖

註 1：VPP 與 RST 復用同一接口，非燒錄 EPROM 時禁止輸入電壓超過 5.8V

註 2：TST 與 PT1.3 復用同一接口，操作時禁止輸入電壓超過 VDD+0.3V

註 3：若不將 PT1.3 設定成外部引腳按鍵，可以提升抗干擾能力

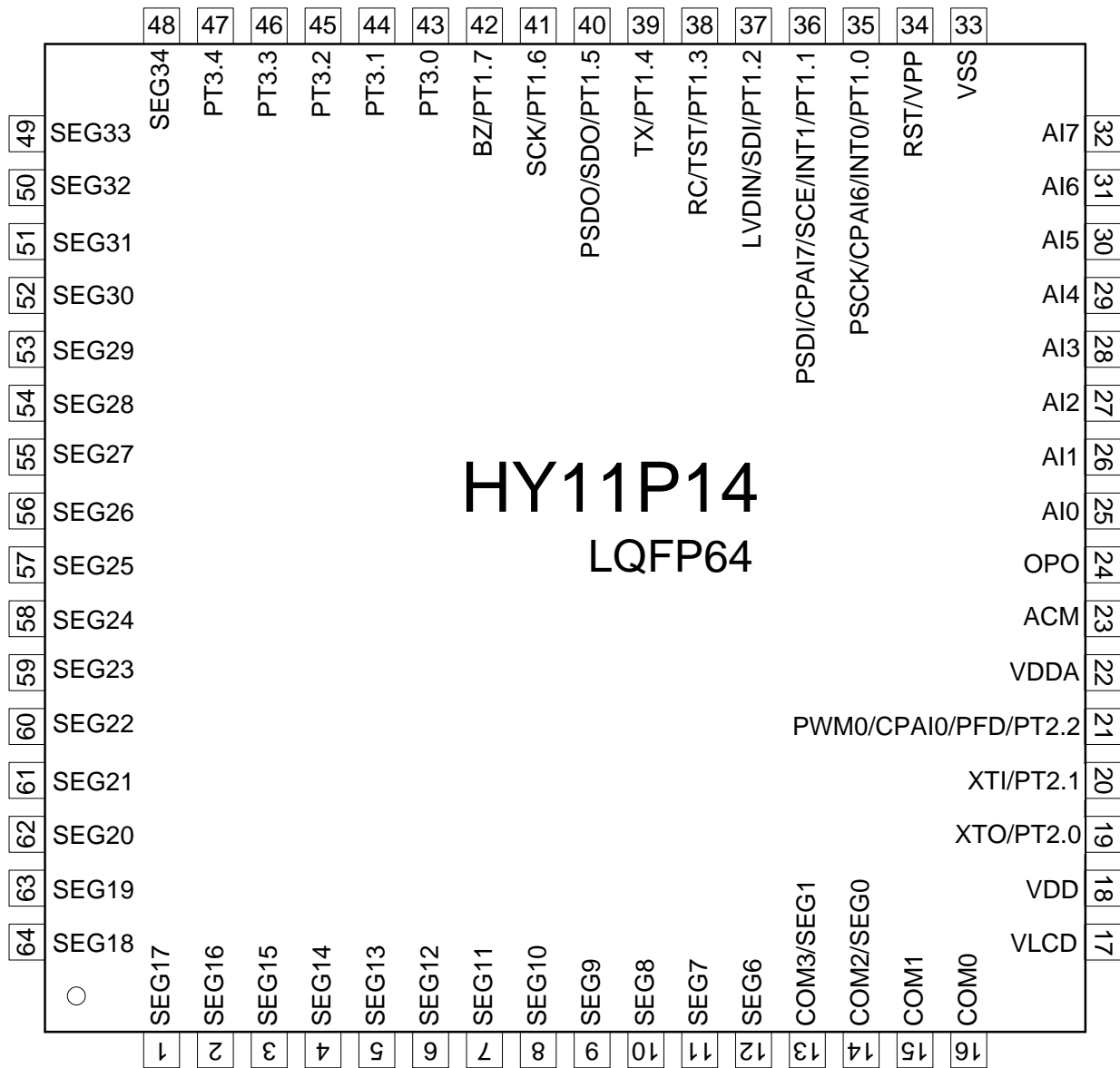
2.3 I/O 引腳定義

“I/O”輸入/輸出,“I”輸入,“O”輸出,“S”史密斯觸發,“C”CMOS 特性兼容輸出與輸入,“P”電壓源,“A”類比通道

LQFP64 引腳編號	LQFP100 引腳編號	引腳名稱	引腳特性		功能說明	
			格 式	緩 衝		
34	1	RST/VPP	RST VPP	I P	S P	復位晶片 EPROM 讀/寫時的電壓源
35	2	PT1.0/INT0/PSCK/CPAI6	PT1.0 INT0 PSCK CPAI6	I I I I	S S S A	數位輸入 中斷源 INT0 OTP 讀/寫介面 SCK 接口 ECPA 類比輸入通道
36	3	PT1.1/INT1/PSDI/SCE/CPAI7	PT1.1 INT1 PSDI SCE CPAI7	I I I I/O I	S S S S A	數位輸入 中斷源 INT1 OTP 讀/寫介面 SDI 接口 SPI 通訊介面 SCE 接口 ECPA 類比輸入通道
37	4	PT1.2/SDI/LVDIN	PT1.2 SDI LVDIN	I I/O A	S S A	數位輸入 SPI 通訊介面 SDI 接口 LVD 外部信號輸入接口
38	5	PT1.3/TST/RC	PT1.3 RC TST	I I I	S S S	數位輸入 EUART 通訊介面 RC 接口 測試模式致能輸入 (未開放)
39	6	PT1.4/TX	PT1.4 TX	I/O I/O	S S	數位輸入/輸出 EUART 通訊介面 TX 接口
40	7	PT1.5/PSDO/SDO	PT1.5 PSDO SDO	I/O O I/O	S C S	數位輸入/輸出 OTP 讀/寫介面 SDO 接口 SPI 通訊介面 SDO 接口
41	8	PT1.6/SCK	PT1.6 SCK	I/O I/O	S S	數位輸入/輸出 SPI 通訊介面 SCK 接口

HY11P14

Embedded 18-Bit Σ ADC

8-Bit RISC-like Mixed Signal Microcontroller

42	9	PT1.7/BZ	PT1.7 BZ	I/O O	S C	數位輸入/輸出 蜂鳴器輸出端
43	10	PT3.0		I/O	C	數位輸入/輸出
44	11	PT3.1		I/O	C	數位輸入/輸出
45	12	PT3.2		I/O	C	數位輸入/輸出
46	13	PT3.3		I/O	C	數位輸入/輸出
47	14	PT3.4		I/O	C	數位輸入/輸出
-	15	PT3.5		I/O	C	數位輸入/輸出
-	16	PT3.6		I/O	C	數位輸入/輸出
-	17	PT3.7		I/O	C	數位輸入/輸出
-	18	NC		-	-	未使用
-	19	NC		-	-	未使用
-	20	NC		-	-	未使用
-	21	NC		-	-	未使用
-	22	NC		-	-	未使用
-	23	NC		-	-	未使用
-	24	NC		-	-	未使用
-	25	NC		-	-	未使用
-	26	SEG41		O	A	LCD 的 Segment 輸出
-	27	SEG40		O	A	LCD 的 Segment 輸出
-	28	SEG39		O	A	LCD 的 Segment 輸出
-	29	SEG38		O	A	LCD 的 Segment 輸出
-	30	SEG37		O	A	LCD 的 Segment 輸出
-	31	SEG36		O	A	LCD 的 Segment 輸出
-	32	SEG35		O	A	LCD 的 Segment 輸出
48	33	SEG34		O	A	LCD 的 Segment 輸出
49	34	SEG33		O	A	LCD 的 Segment 輸出
50	35	SEG32		O	A	LCD 的 Segment 輸出
51	36	SEG31		O	A	LCD 的 Segment 輸出
52	37	SEG30		O	A	LCD 的 Segment 輸出
53	38	SEG29		O	A	LCD 的 Segment 輸出
54	39	SEG28		O	A	LCD 的 Segment 輸出
55	40	SEG27		O	A	LCD 的 Segment 輸出
56	41	SEG26		O	A	LCD 的 Segment 輸出
57	42	SEG25		O	A	LCD 的 Segment 輸出
58	43	SEG24		O	A	LCD 的 Segment 輸出

HY11P14

Embedded 18-Bit Σ ADC

8-Bit RISC-like Mixed Signal Microcontroller

59	44	SEG23	O	A	LCD 的 Segment 輸出	
60	45	SEG22	O	A	LCD 的 Segment 輸出	
61	46	SEG21	O	A	LCD 的 Segment 輸出	
62	47	SEG20	O	A	LCD 的 Segment 輸出	
63	48	SEG19	O	A	LCD 的 Segment 輸出	
64	49	SEG18	O	A	LCD 的 Segment 輸出	
1	50	SEG17	O	A	LCD 的 Segment 輸出	
2	51	SEG16	O	A	LCD 的 Segment 輸出	
3	52	SEG15	O	A	LCD 的 Segment 輸出	
4	53	SEG14	O	A	LCD 的 Segment 輸出	
5	54	SEG13	O	A	LCD 的 Segment 輸出	
6	55	SEG12	O	A	LCD 的 Segment 輸出	
7	56	SEG11	O	A	LCD 的 Segment 輸出	
8	57	SEG10	O	A	LCD 的 Segment 輸出	
9	58	SEG9	O	A	LCD 的 Segment 輸出	
10	59	SEG8	O	A	LCD 的 Segment 輸出	
11	60	SEG7	O	A	LCD 的 Segment 輸出	
-	61	SEG6	O	A	LCD 的 Segment 輸出	
-	62	SEG5	O	A	LCD 的 Segment 輸出	
-	63	SEG4	O	A	LCD 的 Segment 輸出	
-	64	SEG3	O	A	LCD 的 Segment 輸出	
-	65	SEG2	O	A	LCD 的 Segment 輸出	
13	66	COM3/SEG1	O	A	LCD 的 COM 與 Segment 共用輸出	
14	67	COM2/SEG0	O	A	LCD 的 COM 與 Segment 共用輸出	
15	68	COM1	O	A	LCD 的 COM 輸出	
16	69	COM0	O	A	LCD 的 COM 輸出	
17	70	VLCD	P	P	LCD 的電壓源	
-	71	NC	-	-	未使用	
-	72	NC	-	-	未使用	
-	73	NC	-	-	未使用	
-	74	NC	-	-	未使用	
-	75	NC	-	-	未使用	
18	76	VDD	P	P	晶片工作電壓源	
19	77	PT2.0/XTO	PT2.0	I/O	S	數位輸入/輸出

HY11P14

Embedded 18-Bit Σ ADC

8-Bit RISC-like Mixed Signal Microcontroller

		XTO	A	A	外接振盪器輸出端
20	78	PT2.1/XTI			
		PT2.1	I/O	S	數位輸入/輸出
		XTI	A	A	外接振盪器輸入端
21	79	PT2.2/PWM0/PFD/CPAI0			
		PT2.2	I/O	C	數位輸入/輸出
		PWM0	O	C	PWM 輸出接口
		PFD	O	C	PFD 輸出接口
		CPAI0	I	A	ECPA 類比輸入通道
-	80	PT2.3/TMCKI/CPAI1/PWM1			
		PT2.3	I/O	S	數位輸入/輸出
		TMCKI	I	S	TIMERC 時脈源輸入接口
		CPAI1	I	A	ECPA 類比輸入通道
		PWM1	O	C	PWM 輸出接口
-	81	PT2.4/CCP0/CPAI2/PWM2			
		PT2.4	I/O	S	數位輸入/輸出
		CCP0	I	S	捕捉/比較模式信號接口
		CPAI2	I	A	ECPA 類比輸入通道
		PWM2	O	C	PWM 輸出接口
-	82	PT2.5/CCP1/CPAI3/PWM3			
		PT2.5	I/O	S	數位輸入/輸出
		CCP1	I	S	捕捉/比較模式信號接口
		CPAI3	I	A	ECPA 類比輸入通道
		PWM3	O	C	PWM 輸出接口
-	83	PT2.6/CPAI4/CPAO			
		PT2.6	I/O	C	數位輸入/輸出
		CPAI4	I	A	ECPA 類比輸入通道
		CPAO	I	A	ECPA 比較器輸出接口
-	84	PT2.7/CPAI5/CPAO			
		PT2.7	I/O	C	數位輸入/輸出
		CPAI5	I	A	ECPA 類比輸入通道
		CPAO	I	A	ECPA 比較器輸出接口
22	85	VDDA	P	P	穩壓器輸出 · 類比電路電壓源
23	86	ACM	P	P	內部類比電路共地引腳
24	87	OPO	A	A	運算放大器輸出
25	88	AI0	A	A	類比輸入通道
26	89	AI1	A	A	類比輸入通道
27	90	AI2	A	A	類比輸入通道

HY11P14

Embedded 18-Bit $\Sigma\Delta$ ADC

8-Bit RISC-like Mixed Signal Microcontroller

28	91	AI3		A	A	類比輸入通道
29	92	AI4		A	A	類比輸入通道
30	93	AI5		A	A	類比輸入通道
31	94	AI6		A	A	類比輸入通道
32	95	AI7		A	A	類比輸入通道
-	96	PT5.0/AI8	PT5.0 AI8	I A	C A	數位輸入 類比輸入通道
-	97	PT5.1/AI9	PT5.1 AI9	I A	C A	數位輸入 類比輸入通道
-	98	PT5.2/AI10	PT5.2 AI10	I A	C A	數位輸入 類比輸入通道
-	99	PT5.3/AI11	PT5.3 AI11	I A	C A	數位輸入 類比輸入通道
33	100	VSS		P	P	晶片工作電壓源接地端

表 2-1 引腳定義與功能說明

3. 應用電路

3.1 橋式感測器



圖 3-1 具溫度補償的橋式感測器應用電路

註：使用溫度補償電阻 NTC 基本線路

註：關於 Load Cell 零點電壓位置可透過 DCSET[2:0]進行偏壓調整

4. 功能概述

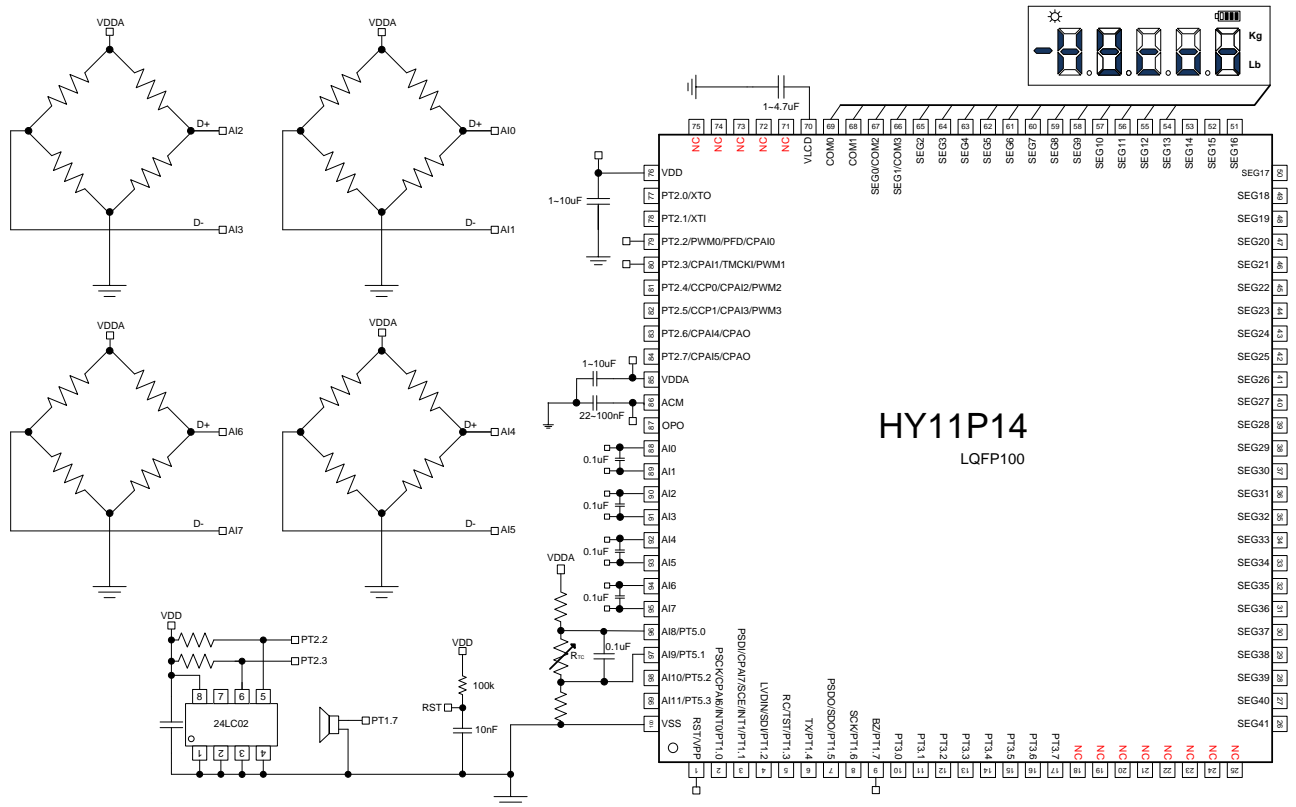
4.1 內部方塊圖

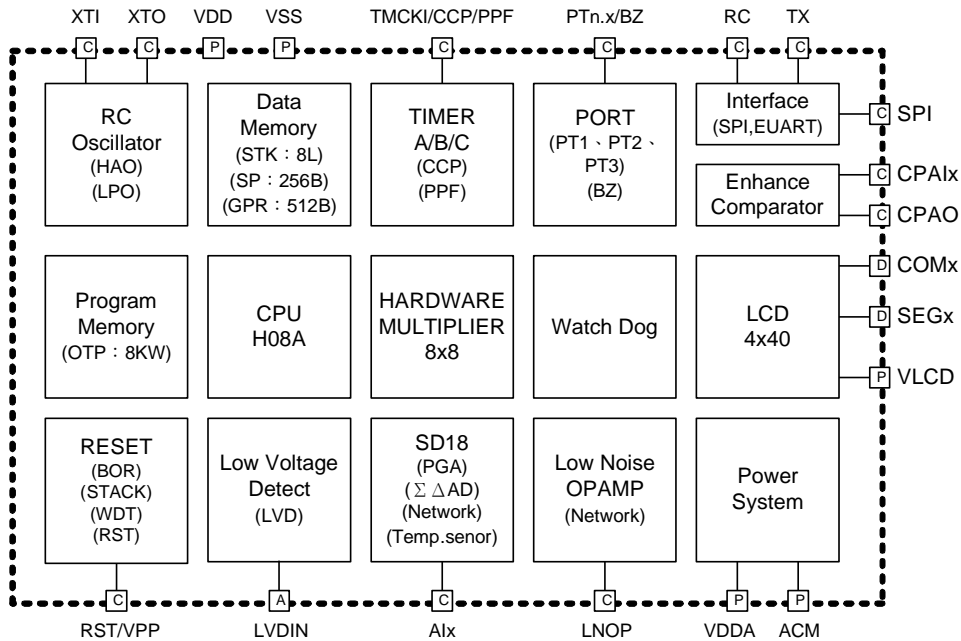

[P] Power Pad [D] Digital Pad [A] Analog Pad [C] Common I/O Pad

圖 4-1 HY11P14 內部方塊圖

4.2 相關說明與支援文件

晶片功能相關使用說明書

- DS-HY11P14-Vxx HY11P14 說明書
- UG-HY11S14-Vxx HY11Pxx 系列使用說明書
- APD-CORE002-Vxx H08A 指令說明書

開發工具相關使用說明書

- APD-HYIDE006-Vxx HY11xxx 系列開發工具軟體使用說明書
- APD-HYIDE005-Vxx HY11xxx 系列開發工具硬體使用說明書
- APD-OTP001-Vxx OTP 產品燒錄引腳說明書

產品生產相關使用說明書

- APD-HYIDE004-Vxx HY1xxxx 系列生產線專用燒錄器說明書
- BDI-HY11P14-Vxx HY11P14 個別產品的裸片打線資訊

4.3 SD18 Network



圖 4-2 SD18 Network

4.4 Low Noise OPAMP Network

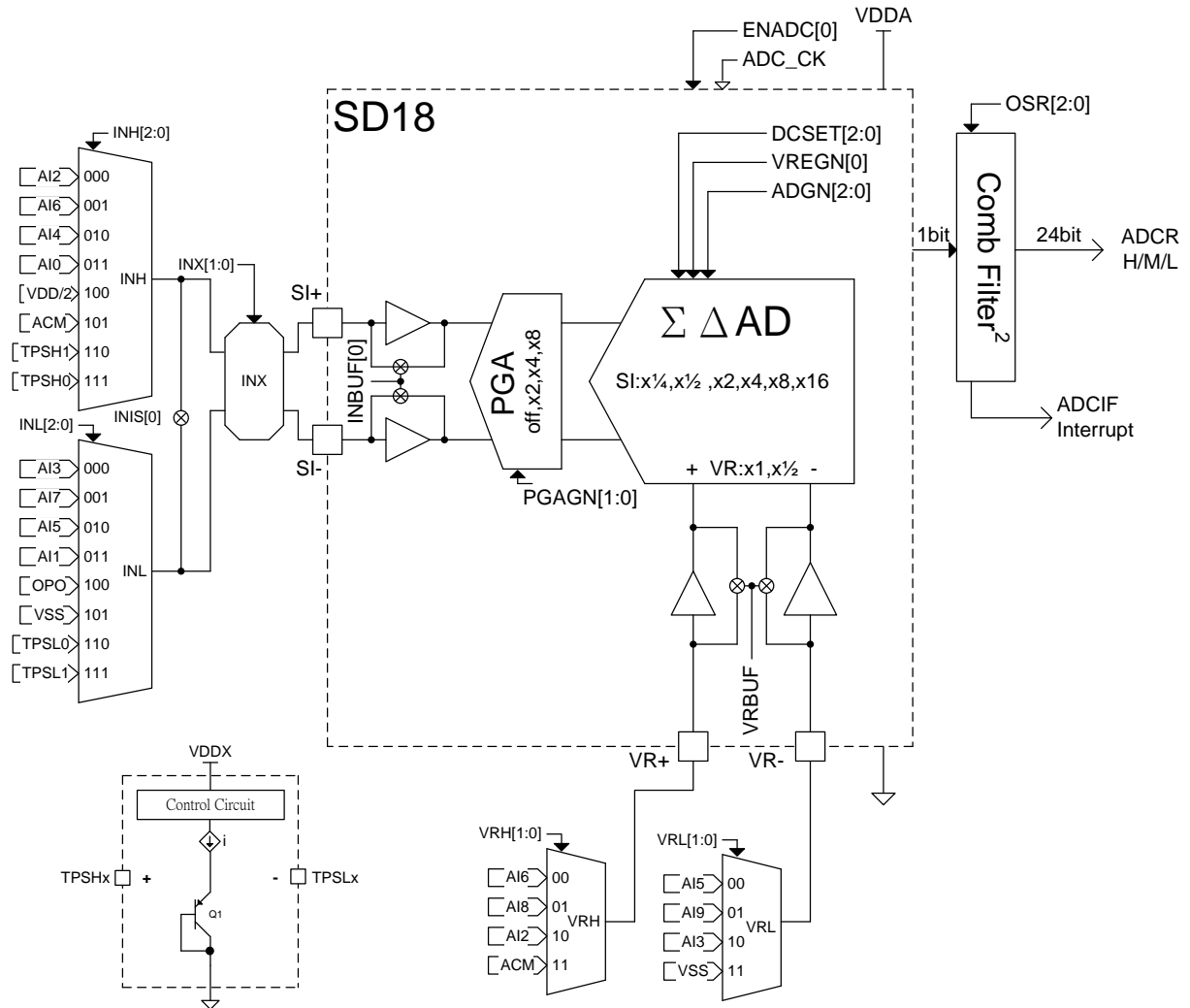
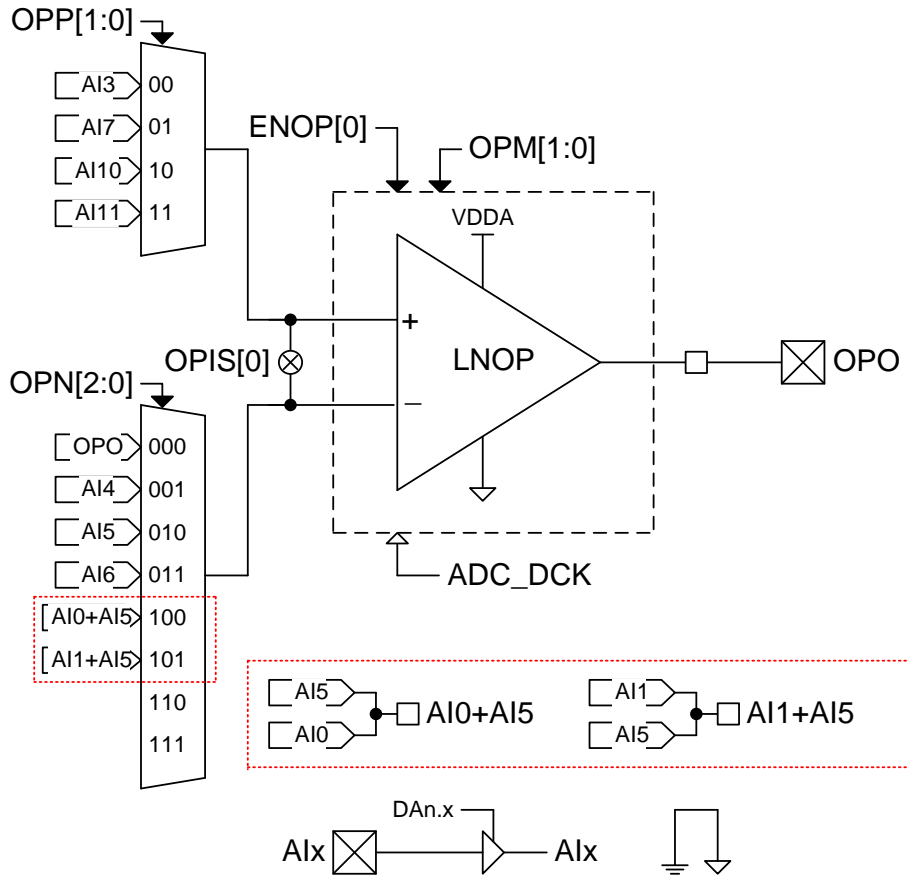

Figure 4-3 Low Noise OPAMP Network

4.5 Enhance Comparator Network



圖 4-4 Enhance Comparator Network

5. 暫存器列表

“-”no use,“*”read/write,“w”write,“r”read,“r0”only read 0,“r1”only read 1,“w0”only write 0,“w1”only write 1														
“.”unimplemented bit,“x”unknown,“u”unchanged,“d”depends on condition														
Address	File Name	Bit7	Bit6	Bit5	Bit4	Bit3	Bit2	Bit1	Bit0	A-RESET	i-RESET	R/W		
00H	INDF0	Contents of FSR0 to address data memory value of FSR0 not changed								N/A	N/A	*****		
01H	POINC0	Contents of FSR0 to address data memory value of FSR0 post-incremented								N/A	N/A	*****		
02H	PODEC0	Contents of FSR0 to address data memory value of FSR0 post-decremented								N/A	N/A	*****		
03H	PRINC0	Contents of FSR0 to address data memory value of FSR0 pre-incremented								N/A	N/A	*****		
04H	PLUSW0	Contents of FSR0 to address data memory value of FSR0 offset by W								N/A	N/A	*****		
05H	INDF1	Contents of FSR1 to address data memory value of FSR0 not changed								N/A	N/A	*****		
06H	POINC1	Contents of FSR1 to address data memory value of FSR0 post-incremented								N/A	N/A	*****		
07H	PODEC1	Contents of FSR1 to address data memory value of FSR0 post-decremented								N/A	N/A	*****		
08H	PRINC1	Contents of FSR1 to address data memory value of FSR0 pre-incremented								N/A	N/A	*****		
09H	PLUSW1	Contents of FSR1 to address data memory value of FSR0 offset by W								N/A	N/A	*****		
0FH	FSROH									FSR0[9]	FSR0[8]xxuu	*****
10H	FSROL	Indirect Data Memory Address Pointer 0 Low Byte,FSR0[7:0]										xxxx xxxx	uuuu uuuu	*****
11H	FSR1H									FSR1[9]	FSR1[8]xxuu	*****
12H	FSR1L	Indirect Data Memory Address Pointer 1 Low Byte,FSR1[7:0]										xxxx xxxx	uuuu uuuu	*****
16H	TOSH					TOS[12]	TOS[11]	TOS[10]	TOS[9]	TOS[8]	...0 0000	...0 0000	*****	
17H	TOSL	Top-of-Stack Low Byte (TOS<7:0>)								0000 0000	0000 0000	*****		
18H	STKPTR	STKFL	STKUN	STKOV				STKPRT[3:0]		000. 0000	000. 0000	r,rw0,rw0-,r,r,r,f		
1AH	PCLATH					PC[12]	PC[11]	PC[10]	PC[9]	PC[8]	...0 0000	...0 0000	*****	
1BH	PCLATL	PC Low Byte for PC<7:0>								0000 0000	0000 0000	*****		
1DH	TBLPTRH					TBLPTR[12]	TBLPTR[11]	TBLPTR[10]	TBLPTR[9]	TBLPTR[8]	...0 0000	...0 0000	*****	
1EH	TBLPTRL	Program Memory Table Pointer Low Byte (TBLPTR<7:0>)								0000 0000	0000 0000	*****		
1FH	TBLDH	Program Memory Table Latch High Byte								0000 0000	0000 0000	*****		
20H	TBLDL	Program Memory Table Latch Low Byte								0000 0000	0000 0000	*****		
21H	PRODH	Product Register of Multiply High Byte								xxxx xxxx	uuuu uuuu	r,r,r,f,r,r,f,f		
22H	PRODL	Product Register of Multiply Low Byte								xxxx xxxx	uuuu uuuu	r,r,r,f,r,r,f,f		
23H	INTE1	GIE	ADCIE	TMCIIE	TMBIE	TMAIE	WDTIE	E1IE	E0IE	0000 0000	0000 0000	*****		
24H	INTE2	TXIE	RCIE			CPOIE	SSPIE	CCP1IE	CCP0IE	00.. 0000	00.. 0000	*****		
26H	INTF1			ADCIF	TMCIF	TMBIF	TMAIF	WDTIF	E1IF	E0IF	.000 0000	.000 0000	*****	
27H	INTF2	TXIF	RCIF			CPOIF	SSPIF	CCP1IF	CCP0IF	00.. 0000	00.. 0000	*****		
29H	WREG	Working Register								xxxx xxxx	uuuu uuuu	*****		
2AH	BSRCN									BSR[1]	BSR[0]0000	*****
2BH	STATUS					C	DC	N	OV	Z	...x xxxx	...u uuuu	*****	
2CH	PSTATUS	PD	TO	IDLEB	BOR			SKERR			000d .0.	uduu .d.	rw0,rw0,rw0,rw0-,rw0,-,r	
2DH	LVDCN			LVDFG	LVD	LVDON	VLDX[3:0]			.000 0000	.000 uuuu	*****		
30H	PWRCN	ENVDDA	VDDAX[1:0]		ENACM					0000	0000	*****		
31H	MCKCN1			ADCS[2:0]	ADCK	XTHSP	XTSP	ENXT	ENHAO	0000 0001	0000 0001	*****		
32H	MCKCN2			LSCK	HSCK	HSS[1:0]		CPUCK[1:0]		.00 0000	.00 0000	*****		
33H	MCKCN3	LCDS[2:0]					PERCK	BZS[2:0]		000. 0000	000. 0000	*****		
34H	CPACN1	ENCPA	CPIST	CPIX	CPIH[1:0]		CPIL[2:0]				0000 0000	0000 0000	*****	
35H	CPACN2			CPOX	CPOFR	CS1	CPAT	CPVCS[1:0]		.000 000.	.000 000.	*****		
36H	CPACN3					CS2	CPVRX[3:0]			...0 0000	...0 0000	*****		
37H	OPCN1	ENOP	OPM[1:0]		OPP[1:0]		OPN[2:0]				0000 0000	0000 0000	*****	
39H	ADCRH	ADC conversion memory HighByte								xxxx xxxx	uuuu uuuu	r,r,r,f,r,r,f,f		
3AH	ADCRM	ADC conversion memory Middle Byte								xxxx xxxx	uuuu uuuu	r,r,r,f,r,r,f,f		
3BH	ADCRL	ADC conversion memory Low Byte								xxxx xxxx	uuuu uuuu	r,r,r,f,r,r,f,f		
3CH	ADCCN1	ENADC	ENHIGN	ENCHP	PGAGN[1:0]		ADGN[2:0]				0000 0000	0000 0000	*****	
3DH	ADCCN2			INBUF	VRBUF	VREGN		DCSET[2:0]		.00 0000	.00 0000	*****		
3EH	ADCCN3	OSR[2:0]								000.	000.	*****		
3FH	AINET1	INH[2:0]			INL[2:0]			INIS	OPIS	0000 0000	0000 0000	*****		
40H	AINET2	VRH[1:0]		INX[1:0]		VRL[1:0]				.000 000.	.000 000.	*****		
41H	TMACN	ENTMA	TMACK	TMAS[1:0]		ENWDT	WDT[2:0]				0000 0000	0000 0000	***** w1,***	
42H	TMAR	TimerA data register								xxxx xxxx	uuuu uuuu	r,r,r,f,r,r,f,f		
43H	TMBCN	ENTMB	TMACK	TMBS[1:0]		TMBSYC	TMBR2R				0000 00..	0000 00..	*****	
44H	TMBRH	TimerB High Byte data register								xxxx xxxx	uuuu uuuu	*****		
45H	TMBRL	TimerB Low Byte data register								xxxx xxxx	uuuu uuuu	*****		
46H	TMCCN	ENTMC	TMCCK[1:0]		TMCS1[2:0]		TMCS0[1:0]				0000 0000	0000 0000	*****	
47H	PRC	TimerC programmable register								1111 1111	1111 1111	*****		
48H	TMCR	TimerC register								0000 0000	0000 0000	r,r,r,f,r,r,f,f		
49H	CCPCN	CCP1M[3:0]				CCP0M[3:0]				0000 0000	0000 0000	*****		
4AH	CCP0RH	CCP0 High Byte data register								xxxx xxxx	uuuu uuuu	*****		
4BH	CCP0RL	CCP0 Low Byte data register								xxxx xxxx	uuuu uuuu	*****		
4CH	CCP1RH	CCP1 High Byte data register								xxxx xxxx	uuuu uuuu	*****		
4DH	CCP1RL	CCP1 Low Byte data register								xxxx xxxx	uuuu uuuu	*****		
4EH	PASC	PASF	PASC[1:0]		PSSCN0[1:0]		PSSCN1[1:0]				0.00 0000	0.00 0000	*****	
4FH	PWMCN	ENPWM	ENPFD	PWMRL[1:0]		PWMCG[1:0]		PWMM[1:0]		0000 0000	0000 0000	*****		
50H	PDBD	DBDC[6:0]								0000 0000	0000 0000	*****		
51H	PWMR	PWM MSB Byte register								xxxx xxxx	uuuu uuuu	*****		

表 5-1(a) HY11P14 暫存器列表

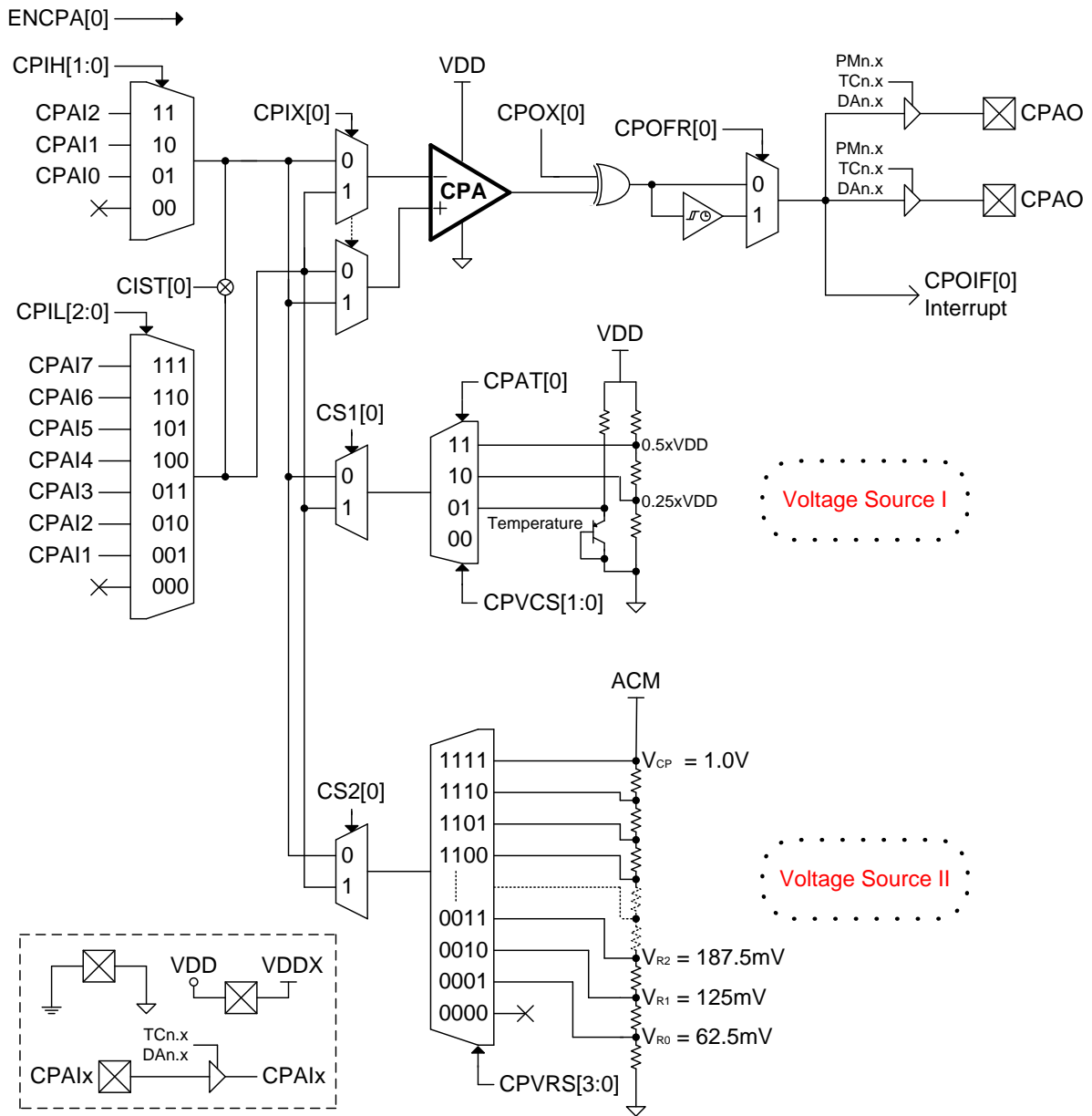
“-”no use,“*”read/write,“w”write,“r”read,“r0”only read 0,“r1”only read 1,“w0”only write 0,“w1”only write 1
“.”unimplemented bit,“x”unknown,“u”unchanged,“d”depends on condition

Address	File Name	Bit7	Bit6	Bit5	Bit4	Bit3	Bit2	Bit1	Bit0	A-RESET	i-RESET	R/W	
52H	LCDCN1	ENLCD	LCDPR	VLCDX[1:0]		LCDBF	LCDB[1:0]			0000 000.	0000 000.	*****-	
53H	LCDCN2	LCDBL	LCDMX[1:0]							000.	000.	***-***-	
54H	LCD0	Segment SEG2@[3:0] and SEG3@[7:4] data register of LCD0											
55H	LCD1	Segment SEG4@[3:0] and SEG5@[7:4] data register of LCD1											
56H	LCD2	Segment SEG6@[3:0] and SEG7@[7:4] data register of LCD2											
57H	LCD3	Segment SEG8@[3:0] and SEG9@[7:4] data register of LCD3											
58H	LCD4	Segment SEG10@[3:0] and SEG11@[7:4] data register of LCD4											
59H	LCD5	Segment SEG12@[3:0] and SEG13@[7:4] data register of LCD5											
5AH	LCD6	Segment SEG14@[3:0] and SEG15@[7:4] data register of LCD6											
5BH	LCD7	Segment SEG16@[3:0] and SEG17@[7:4] data register of LCD7											
5CH	LCD8	Segment SEG18@[3:0] and SEG19@[7:4] data register of LCD8											
5DH	LCD9	Segment SEG20@[3:0] and SEG21@[7:4] data register of LCD9											
5EH	SSPCON1	SSPEN	CKP	CKE	SMP	—	—	SSPM<1:0>		0000 ..00	uuuu ..uu	*****	
60H	SSPSTA	SSPBUY	SSPOV	Reserve for IIC						BF	00.0	00.0	r,r,r,r,r,r,r
61H	SSPBUF	SSP Receive Buffer/Transmit Register											
63H	URCON	ENSP	ENTX	TX9	TX9D	PARITY			WUE	0000 0..0	0000 0..0	*****	
64H	URSTA		RC9D	PERR	FERR	OERR	RCIDL	TRMT	ABDOVF	.000 0110	.000 0110	r,r,r,r,r,r,r,w0	
65H	BAUDCON					ENCR	RC9	ENADD	ENABD 0000 0000	*****	
66H	BRGRH	Baud Rate Generator Register High Byte											
67H	BRGRL	Baud Rate Generator Register Low Byte											
68H	TXREG	UART Transmit Register											
69H	RCREG	UART Receive Register											
6DH	PT1	PT1.7	PT1.6	PT1.5	PT1.4	PT1.3	PT1.2	PT1.1	PT1.0	xxxx xxxx	uuuu uuuu	*****	
6EH	TRISC1	TC1.7	TC1.6	TC1.5	TC1.4					0000	0000	*****	
6FH	PT1DA						DA1.2	DA1.1	DA1.0000000	*****	
70H	PT1PU	PU1.7	PU1.6	PU1.5	PU1.4	PU1.3	PU1.2	PU1.1	PU1.0	0000 0000	0000 0000	*****	
71H	PT1M1					INTEG1[1:0]		INTEG0[1:0]	 0000 0000	*****	
72H	PT1M2		PM1.7[0]		PM1.6[0]		PM1.5[0]		PM1.4[0]	.0.0 .0.0	.0.0 .0.0	*****	
74H	PT2	PT2.7	PT2.6	PT2.5	PT2.4	PT2.3	PT2.2	PT2.1	PT2.0	xxxx xxxx	uuuu uuuu	*****	
75H	TRISC2	TC2.7	TC2.6	TC2.5	TC2.4	TC2.3	TC2.2	TC2.1	TC2.0	0000 0000	0000 0000	*****	
76H	PT2DA	DA2.7	DA2.6	DA2.5	DA2.4	DA2.3	DA2.2			0000 00..	0000 00..	*****	
77H	PT2PU	PU2.7	PU2.6	PU2.5	PU2.4	PU2.3	PU2.2	PU2.1	PU2.0	0000 0000	0000 0000	*****	
78H	PT2M1		PM2.3[0]	PM2.2[1]	PM2.2[0]					.000000	*****	
79H	PT2M2	PWMTR[1:0]			PM2.6[0]	PM2.5[1]	PM2.5[0]	PM2.4[1]	PM2.4[0]	00.0 0000	00.0 0000	*****	
7AH	PT3	PT3.7	PT3.6	PT3.5	PT3.4	PT3.3	PT3.2	PT3.1	PT3.0	xxxx xxxx	uuuu uuuu	*****	
7BH	TRISC3	TC3.7	TC3.6	TC3.5	TC3.4	TC3.3	TC3.2	TC3.1	TC3.0	0000 0000	0000 0000	*****	
7DH	PT3PU	PU3.7	PU3.6	PU3.5	PU3.4	PU3.3	PU3.2	PU3.1	PU3.0	0000 0000	0000 0000	*****	
80H ~ FFH		GENERAL PURPOSE REGISTER @ 128Byte											
100H~17FH		GENERAL PURPOSE REGISTER @ 128Byte											
180H	LCD10	Segment SEG22@[3:0] and SEG23@[7:4] data register of LCD10											
181H	LCD11	Segment SEG24@[3:0] and SEG25@[7:4] data register of LCD11											
182H	LCD12	Segment SEG26@[3:0] and SEG27@[7:4] data register of LCD12											
183H	LCD13	Segment SEG28@[3:0] and SEG29@[7:4] data register of LCD13											
184H	LCD14	Segment SEG30@[3:0] and SEG31@[7:4] data register of LCD14											
185H	LCD15	Segment SEG32@[3:0] and SEG33@[7:4] data register of LCD15											
186H	LCD16	Segment SEG34@[3:0] and SEG35@[7:4] data register of LCD16											
187H	LCD17	Segment SEG36@[3:0] and SEG37@[7:4] data register of LCD17											
188H	LCD18	Segment SEG38@[3:0] and SEG39@[7:4] data register of LCD18											
189H	LCD19	Segment SEG40@[3:0] and SEG41@[7:4] data register of LCD19											
192H	PT5					PT5.3	PT5.2	PT5.1	PT5.0 xxxx uuuu	*****	
193H	PT5DA					DA5.3	DA5.2	DA5.1	DA5.0 1111 1111	*****	
194H	PT5PU					PU5.3	PU5.2	PU5.1	PU5.0 0000 0000	*****	
200H ~ 2FFH		GENERAL PURPOSE REGISTER @ 256Byte											

圖 5-1(b) HY11P14 暫存器列表(續)

6. 電氣特性

Absolute maximum ratings over operating free-air temperature (unless otherwise noted)

Voltage applied at V _{DD} to V _{SS}	-0.2 V to 4.0 V
Voltage applied to any pin	-0.2 V to V _{DD} + 0.3 V
Voltage applied to RST/VPP pin	-0.2 V to 6.9 V
Voltage applied to TST/PT1.3 pin	-0.2 V to V _{DD} + 1 V
Diode current at any device terminal	±2 mA
Storage temperature, Tstg: (unprogrammed device)	-55°C to 150°C
(programmed device)	-40°C to 85°C
Total power dissipation	0.5w
Maximum output current sink by any PORT1 to PORT3 I/O pin25mA

6.1 Recommended operating conditions

T_A = -40°C ~ 85°C, unless otherwise noted

Sym.	Parameter		Test Conditions		Min.	Typ.	Max.	unit
V _{DD}	Supply Voltage		All digital peripherals and CPU		2.2		3.6	V
			Analog peripherals		2.4		3.6	
V _{SS}	Supply Voltage				0		0	
XT	External	Watch crystal	V _{DD} = 2.2V, ENXT[0]=1	XTSP[0]=0, XTHSP[0]=0	32.768K		Hz	
	Oscillator	Ceramic resonator		XTSP[0]=1, XTHSP[0]=0	450K	8M		
	Frequency	Crystal		XTSP[0]=1, XTHSP[0]=0	1M	8M		

6.2 Internal RC Oscillator

$T_A = 25^\circ\text{C}, V_{DD} = 3.0\text{V}$, unless otherwise noted

Sym.	Parameter	Test Conditions	Min.	Typ.	Max.	unit
HAO	High Speed Oscillator frequency	ENHAO[0]=1	1.8	2.0	2.2	MHz
LPO	Low Power Oscillator frequency	V_{DD} supply voltage be enable LPO	22	28	35	KHz

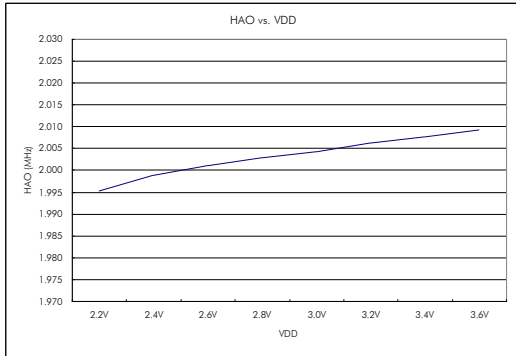

Figure 6.2-1 HAO vs. VDD

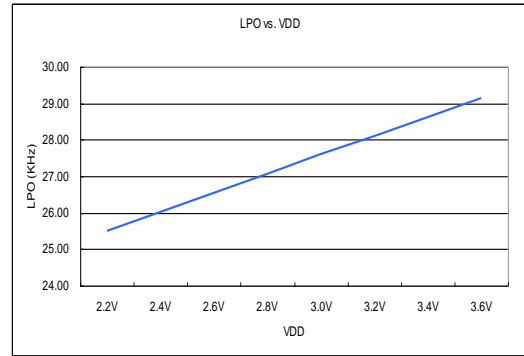

Figure 6.2-2 LPO vs. VDD

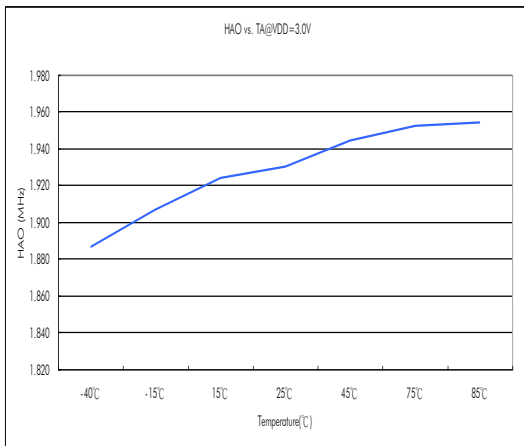

Figure 6.2-3 HAO vs. Temperature

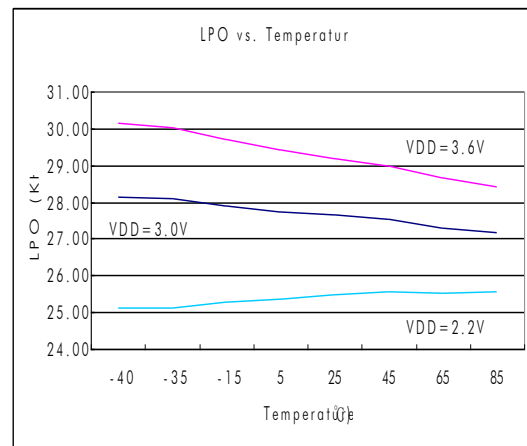

Figure 6.2-4 LPO vs. Temperature

6.3 Supply current into VDD excluding peripherals current

$T_A = 25^\circ\text{C}, V_{DD} = 3.0\text{V}, \text{OSC_LPO} = 28\text{KHz}$, unless otherwise noted

Sym.	Parameter	Test Conditions	Min.	Typ.	Max.	unit
I_{AM1}	Active mode 1	OSC_CY = 8MHz, OSC_HAO = off, CPU_CK = 8MHz		1.34	2	mA
I_{AM2}	Active mode 2	OSC_CY = off, OSC_HAO = 2MHz, CPU_CK = 2MHz		0.36	0.55	mA
I_{AM3}	Active mode 3	OSC_CY = off, OSC_HAO = 2MHz, CPU_CK = 1MHz		0.2	0.3	mA
I_{LP1}	Low Power 1	OSC_CY = 32768Hz, OSC_HAO = off, CPU_CK = 16384Hz		7	12	μA
I_{LP2}	Low Power 2	OSC_CY = off, OSC_HAO = off, CPU_CK = LPO, Idle state		1.65	3	μA
I_{LP3}	Low Power 3	OSC_CY = off, OSC_HAO = off, CPU_CK = off, Sleep state		0.65	1.2	μA

OSC_CY : External Oscillator frequency.

OSC_HAO : Internal High Accuracy Oscillator frequency.

CPU_CK : CPU core work frequency.

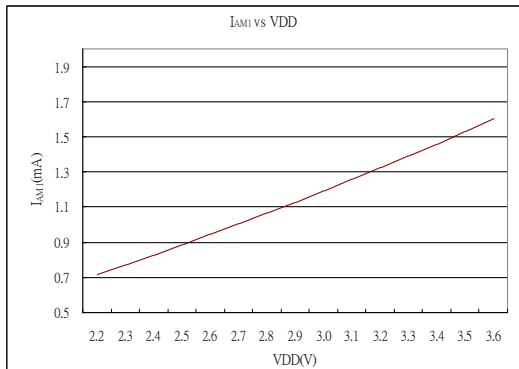

Figure 6.3-1 I_{AM1} vs. VDD

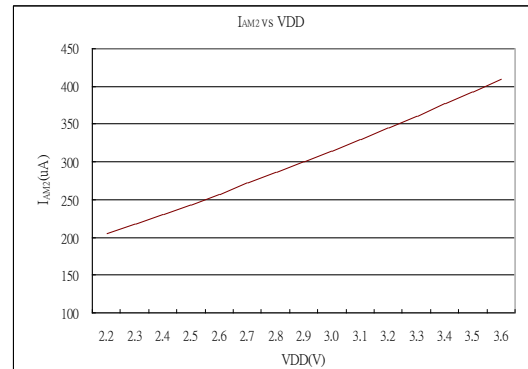

Figure 6.3-2 I_{AM2} vs. VDD

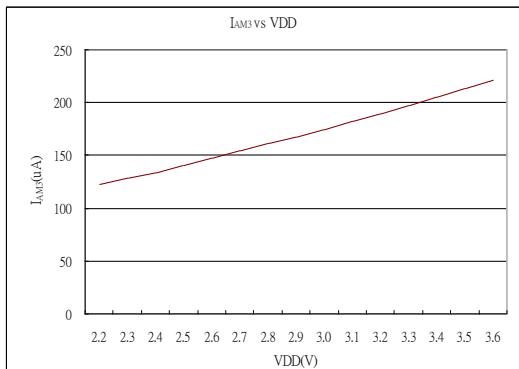

Figure 6.3-3 I_{AM3} vs. VDD

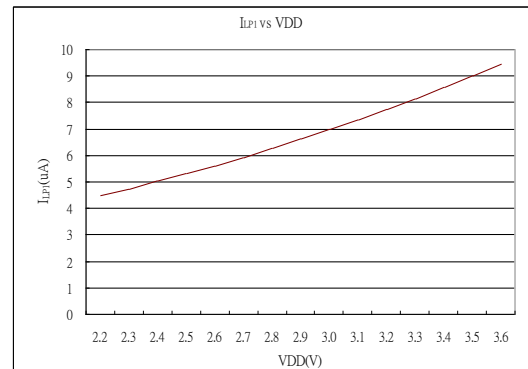

Figure 6.3-4 I_{LP1} vs. VDD

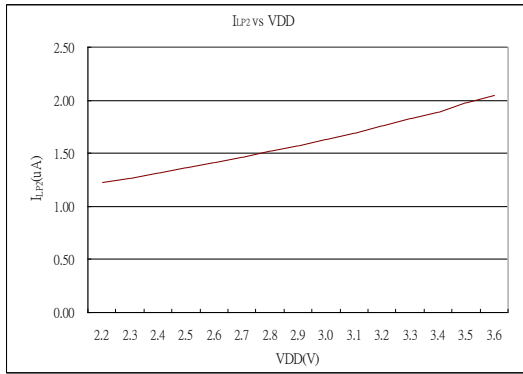

Figure 6.3-5 I_{LP2} vs. VDD

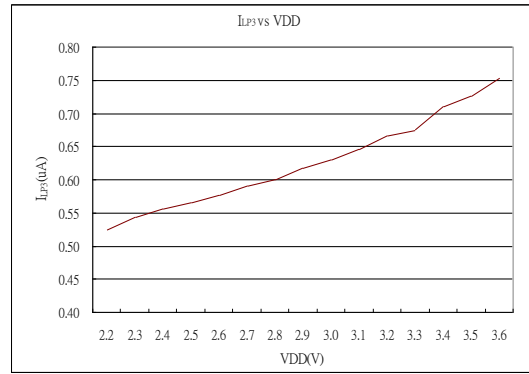

Figure 6.3-6 I_{LP3} vs. VDD

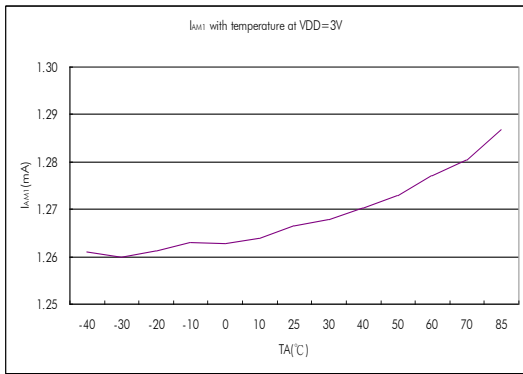

Figure 6.3-7 I_{AM1} vs. Temperature

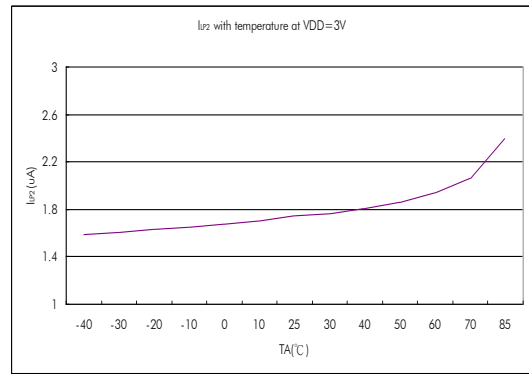

Figure 6.3-8 I_{LP2} vs. Temperature

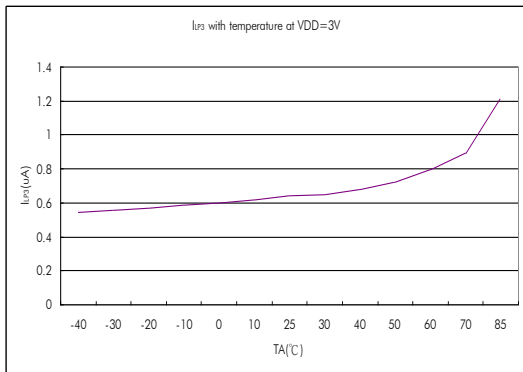

Figure 6.3-9 I_{LP3} vs. Temperature

6.4 Port1~5

$T_A = 25^\circ\text{C}, V_{DD} = 3.0\text{V}$, unless otherwise noted

Sym.	Parameter	Test Conditions	Min.	Typ.	Max.	unit
Input voltage and Schmitt trigger and leakage current and timing						
V_{IH}	High-Level input voltage				2.1	V
V_{IL}	Low-Level input voltage		0.9			
V_{hys}	Input Voltage hysteresis($V_{IH} - V_{IL}$)			0.8		V
I_{LKG}	Leakage Current				0.1	μA
R_{PU}	Port pull high resistance			180		$\text{k}\Omega$
Output voltage and current and frequency						
V_{OH}	High-level output voltage	$I_{OH}=10\text{mA}$	$V_{DD} - 0.3$			V
V_{OL}	Low-level output voltage	$I_{OL}=-10\text{mA}$			$V_{SS} + 0.3$	

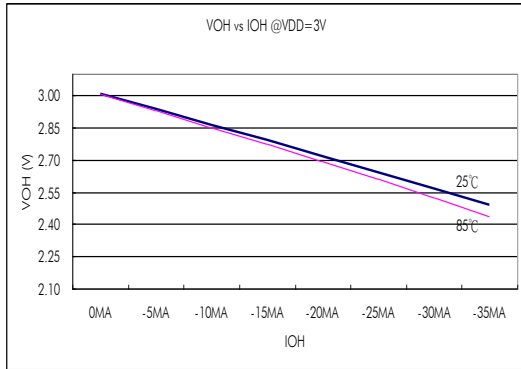

Figure 6.4-1 V_{OH} vs. I_{OH} @ $V_{DD}=3.0\text{V}$

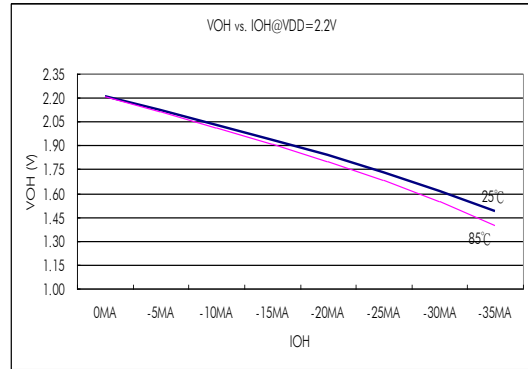

Figure 6.4-2 V_{OH} vs. I_{OH} @ $V_{DD}=2.2\text{V}$

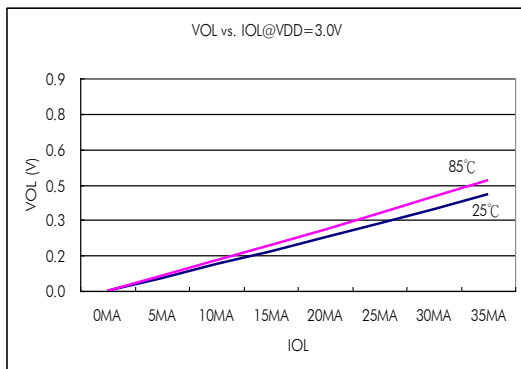

Figure 6.4-3 V_{OL} vs. I_{OL} @ $V_{DD}=3.0\text{V}$

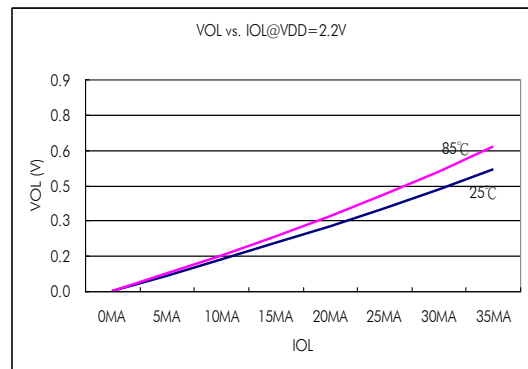

Figure 6.4-4 V_{OL} vs. I_{OL} @ $V_{DD}=2.2\text{V}$

6.5 Reset(Brownout, External RST pin, Low Voltage Detect)

$T_A = 25^\circ\text{C}, V_{DD} = 3.0\text{V}$, unless otherwise noted

Sym.	Parameter	Test Conditions	Min.	Typ.	Max.	unit	
BOR	Pulse length needed to accepted reset internally, t_{d-LVR}		2			us	
	V_{DD} Start Voltage to accepted reset internally (L→H), V_{LVR}		1.6	1.85	2.1	V	
	Hysteresis, $V_{HYS-LVR}$			70		mV	
RST	Pulse length needed as RST/VPP pin to accepted reset internally, t_{d-RST}		2			us	
	Input Voltage to accepted reset internally		0.9			V	
	Hysteresis, $V_{HYS-RST}$			0.8		V	
LVD	Operation current, I_{LVD}			10	15	uA	
	External input voltage to compare reference voltage			1.2		V	
	Compare reference voltage temperature drift	$T_A = -40^\circ\text{C} \sim 85^\circ\text{C}$		100		ppm/ $^\circ\text{C}$	
	Detect V_{DD} voltage rang by user option, $V_{SVS} VLDx[3:0]=1110b$			3.3		V	
	Detect V_{DD} voltage rang by user option, $V_{SVS} VLDx[3:0]=1101b$			3.2			
	Detect V_{DD} voltage rang by user option, $V_{SVS} VLDx[3:0]=1100b$			3.1			
	Detect V_{DD} voltage rang by user option, $V_{SVS} VLDx[3:0]=1011b$			3.0			
	Detect V_{DD} voltage rang by user option, $V_{SVS} VLDx[3:0]=1010b$			2.9			
	Detect V_{DD} voltage rang by user option, $V_{SVS} VLDx[3:0]=1001b$			2.8			
	Detect V_{DD} voltage rang by user option, $V_{SVS} VLDx[3:0]=1000b$			2.7			
	Detect V_{DD} voltage rang by user option, $V_{SVS} VLDx[3:0]=0111b$			2.6			
	Detect V_{DD} voltage rang by user option, $V_{SVS} VLDx[3:0]=0110b$			2.5			
	Detect V_{DD} voltage rang by user option, $V_{SVS} VLDx[3:0]=0101b$			2.4			
	Detect V_{DD} voltage rang by user option, $V_{SVS} VLDx[3:0]=0100b$			2.3			
	Detect V_{DD} voltage rang by user option, $V_{SVS} VLDx[3:0]=0011b$			2.2			
	Detect V_{DD} voltage rang by user option, $V_{SVS} VLDx[3:0]=0010b$			2.1			
Detect V_{DD} voltage rang by user option, $V_{SVS} VLDx[3:0]=0001b$			2.0				
BOR : Brownout Reset LVR : Low Voltage Reset of BOR LVD : Low Voltage Detect RST : External Reset pin							

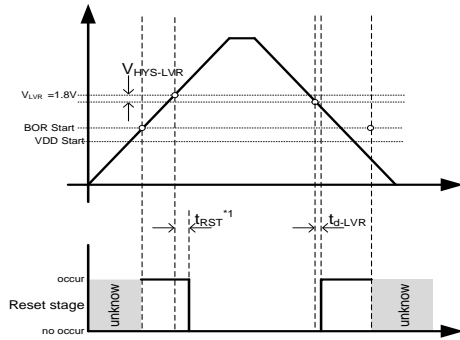

Figure 6.5-1 BOR reset diagram

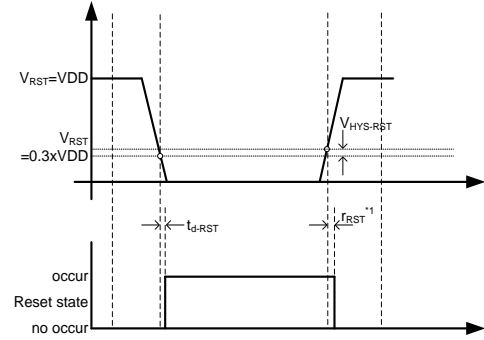

Figure 6.5-2 RST reset diagram

*1 t_{RST} : Please see BOR Introduce of HY11Pxx series User's Guide (UG-HY11S14-Vxx).

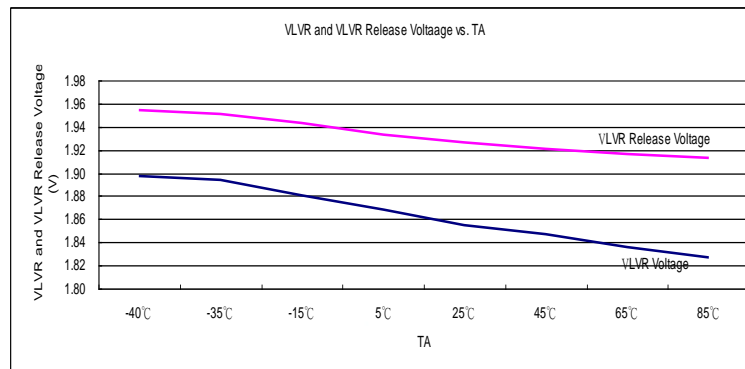

Figure 6.5-3 LVR vs. Temperature

6.6 Power System

$T_A = 25^\circ\text{C}, V_{DD} = 3.0\text{V}$, unless otherwise noted

Sym.	Parameter	Test Conditions		Min.	Typ.	Max.	unit	
VDDA	VDDA operation current, I_{VDDA}	$I_L = 0\text{mA}$	VDDAX[1:0]=00b		22		μA	
	Select VDDA output voltage	$I_L = 0.1\text{mA}$, $V_{DD} \geq V_{VDDA} + 0.2\text{V}$	VDDAX[1:0]=00b		3.3		V	
			VDDAX[1:0]=01b		2.9		V	
			VDDAX[1:0]=10b		2.6		V	
			VDDAX[1:0]=11b		2.4		V	
	Dropout voltage	$I_L = 10\text{mA}$	VDDAX[1:0]=00b			135		mV
			VDDAX[1:0]=01b			150		mV
VDDAX[1:0]=10b					165		mV	
VDDAX[1:0]=11b					180		mV	
Temperature drift	VDDAX[1:0]=11b	$T_A = -40^\circ\text{C} \sim 85^\circ\text{C}$		50		ppm/ $^\circ\text{C}$		
V_{DD} Voltage drift	$I_L = 0.1\text{mA}$	$V_{DD} = 2.5\text{V} \sim 3.6\text{V}$		± 0.2		%/V		
ACM	ACM operation current, I_{ACM}	$I_L = 0\text{mA}$			20		μA	
	Output voltage, V_{ACM}	ENACM[0]=1, *1	$I_L = 0\mu\text{A}$		1.0		V	
	Output voltage with Load		$I_L = \pm 200\mu\text{A}$	0.98	1.02	V_{ACM}		
	Output voltage, V_{ACM}	ENACM[0]=1, *2	$I_L = 0\mu\text{A}$		1.2		V	
	Output voltage with Load		$I_L = \pm 200\mu\text{A}$	0.98	1.02	V_{ACM}		
	Temperature drift	ENACM[0]=1,	$T_A = -40^\circ\text{C} \sim 85^\circ\text{C}$		50		ppm/ $^\circ\text{C}$	
	V_{DDA} Voltage drift	$I_L = 10\mu\text{A}$			100		$\mu\text{V}/\text{V}$	

VDDA : Adjust Voltage Regulator
 ACM : Analog Common Mode Voltage

*1: $V_{ACM} = 1.0\text{V}$ is just for VDDAX[1:0]=1xb mode. (at A/D differential voltage reference < 1.4V)
 *2: $V_{ACM} = 1.2\text{V}$ is just for VDDAX[1:0]=0xb mode. (at A/D differential voltage reference > 1.4V)

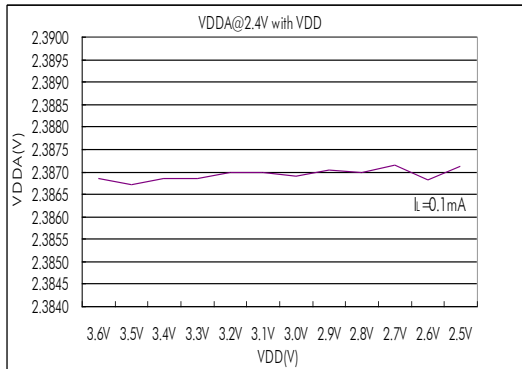

Figure 6.6-1 VDDA $I_L=0.1\text{mA}$ vs. VDD

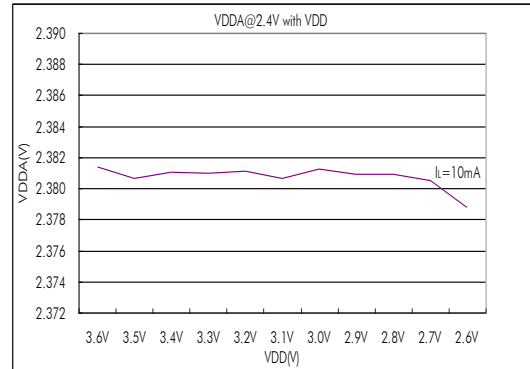

Figure 6.6-2 VDDA $I_L=10\text{mA}$ vs. VDD

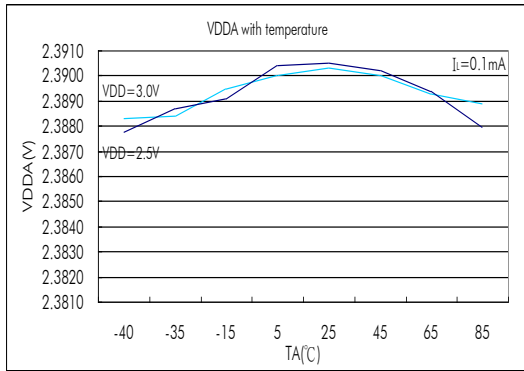

Figure 6.6-3 VDDA $I_L=0.1\text{mA}$ vs. Temperature

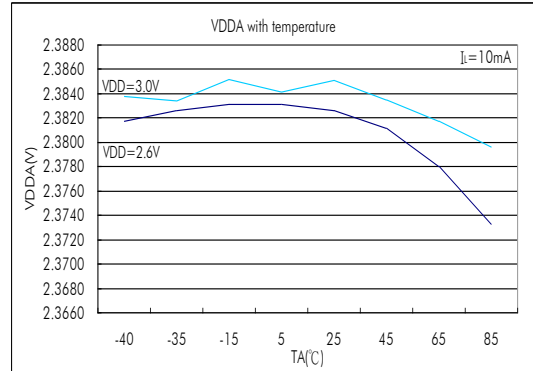

Figure 6.6-4 VDDA $I_L=10\text{mA}$ vs. Temperature

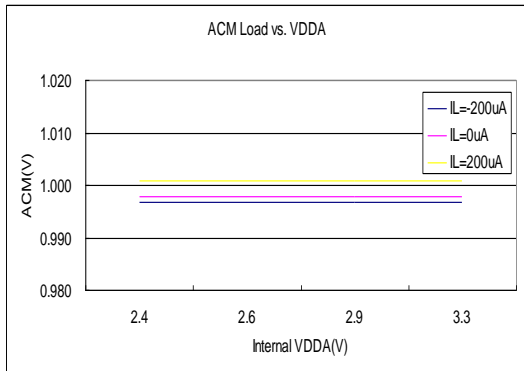

Figure 6.6-5 ACM Load vs. VDDA (a)

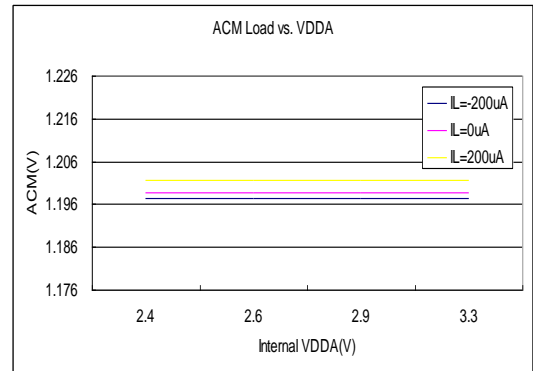

Figure 6.6-5 ACM Load vs. VDDA (b)

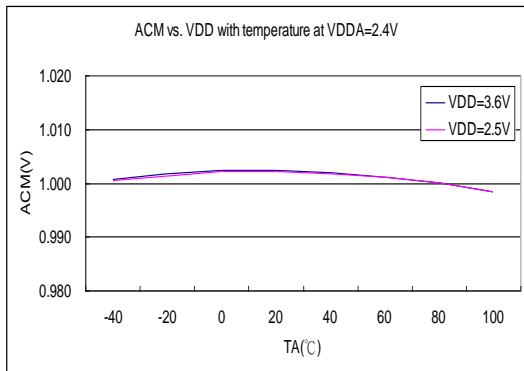

Figure 6.6-6 ACM vs. Temperature (a)

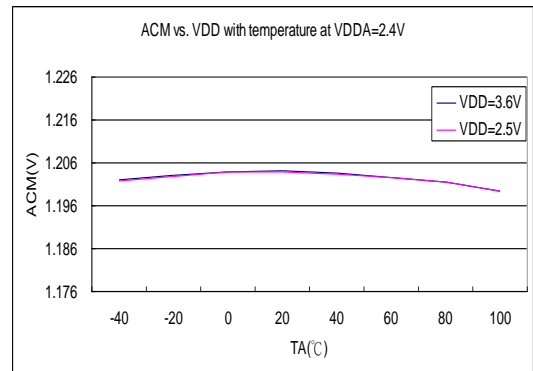

Figure 6.6-6 ACM vs. Temperature (b)

6.7 LCD

$T_A = 25^\circ\text{C}, V_{DD} = 3.0\text{V}, C_{VLCD} = 4.7\mu\text{F}$, unless otherwise noted.

Sym.	Parameter	Test Conditions		Min.	Typ.	Max.	unit
I_{LCD}	Operation supply current without output buffer.(all segment turn on)	LCDPR[0]=1	$V_{DD} = 2.2\text{V}$	10			uA
		LCDPR[0]=1, LCDS_CK=122hz	$V_{DD} = 3.0\text{V}$				
VLCD	Supply Voltage at VLCD pin	LCDPR[0]=0		2.2		3.6	V
	Embedded Charge Pump output voltage at VLCD pin	$V_{DD} = 2.2\text{V}$, LCDPR[0]=1, $C_{VLCD} = 4.7\mu\text{F}$	VLCDX[1:0]=11b	2.295	2.55	2.805	V
			VLCDX[1:0]=10b	2.52	2.8	3.08	
			VLCDX[1:0]=01b	2.745	3.05	3.355	
VLCDX[1:0]=00b	2.97	3.3	3.63				
Z_{LCD}	Output impedance with LCD buffer	$f_{LCD} = 128\text{Hz}, VLCD = 3.05\text{V}$		10			k Ω

曲線圖：

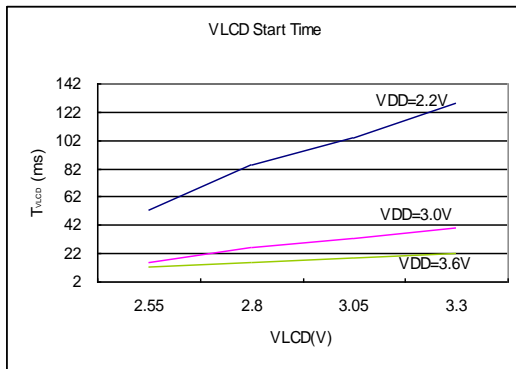

Figure6.7-1 LCD start time

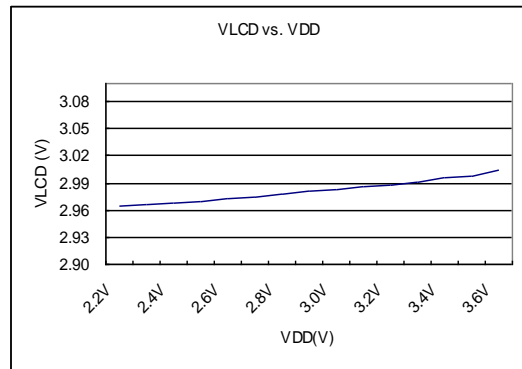

Figure6.7-2 VLCD vs. VDD

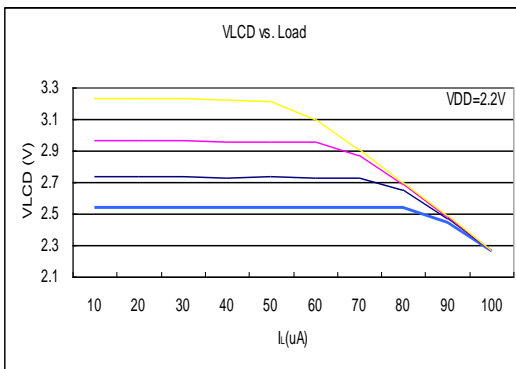

Figure6.7-3 VLCD vs. IL @ VDD=2.2V

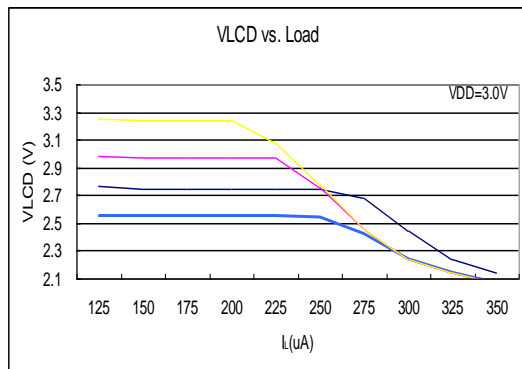

Figure6.7-4 VLCD vs. IL @ VDD=3.0V

6.8 Low Noise OPAMP

$T_A = 25^\circ\text{C}, V_{DD} = 3.0\text{V}, V_{DDA}=2.4\text{V}$, unless otherwise noted

Sym.	Parameter	Test Conditions		Min.	Typ.	Max.	unit
V_{LNOP}	Supply voltage at VDDA	ENVDDA[0]=0		2.4		3.6	V
I_{LNOP}	Operation supply current		OPM[1:0]=xxb		200		μA
V_{OS-OP}	Input offset voltage without chopper.		OPM[1:0]=1xb	-2		2	mV
	Input offset voltage with chopper		OPM[1:0]=0xb		20		μV
	Input offset voltage temperature drift.	OPM[1:0]=00b	$T_A=-40^\circ\text{C} \sim 85^\circ\text{C}$		0.1		$\mu\text{V}/^\circ\text{C}$
OPM[1:0]=10				2			
V_{OLR}	Unit gain load regulation	$V_O=1.2\text{V},$ $V_{DDA}=2.4\text{V}$	$I_L=+1\text{mA}$		0.1		$\%V_O$
			$I_L=-1\text{mA}$				
CMVR	Common-mode voltage input range		OPM[1:0]=xxb	0.1		$V_{DDA}-1.1$	V
CMRR	Common-mode rejection ratio		OPM[1:0]=xxb		90		dB

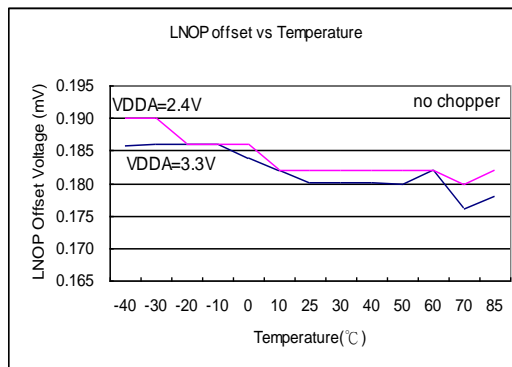

Figure6.8-1 LNOP Offset Temperature

6.9 SD18, Power Supply and recommended operating conditions

$T_A = 25^\circ\text{C}$, $V_{DD} = 3.0\text{V}$, $V_{DDA} = 2.4\text{V}$, unless otherwise noted

Sym.	Parameter	Test Conditions		Min.	Typ.	Max.	unit
V_{SD18}	Supply Voltage at VDDA	ENVDDA[0]=0		2.4		3.6	V
f_{SD18}	Modulator sample frequency, ADC_CK			25	250	300	KHz
	Over Sample Ratio, OSR			256		32768	
I_{SD18}	Operation supply current without PGA	ENADC[0]=1 INBUF[0]=1, VRBUF[0]=0	GAIN =4, ADC_CK=250KHz	168		uA	
		ENADC[0]=1 INBUF[0]=0, VRBUF[0]=1		150			
		ENADC[0]=1 INBUF[0]=0, VRBUF[0]=0		120			

6.10 PGA, Power Supply and recommended operating conditions

$T_A = 25^\circ\text{C}$, $V_{DD} = 3.0\text{V}$, $V_{DDA} = 2.4\text{V}$, unless otherwise noted

Sym.	Parameter	Test Conditions		Min.	Typ.	Max.	unit
V_{PGA}	Supply Voltage at VDDA	ENVDDA[0]=0		2.4		3.6	V
I_{PGA}	Operation supply current	PGAGN[1:0]=<01> or <1x>			320		uA
G_{PGA}	Gain temperature drift	$T_A = -40^\circ\text{C} \sim 85^\circ\text{C}$	GAIN=128		5		ppm/ $^\circ\text{C}$

6.11 SD18, performance II ($f_{SD18} = 250\text{KHz}$)

$T_A = 25^\circ\text{C}$, $V_{DD} = 3.0\text{V}$, $V_{DDA} = 2.9\text{V}$, $V_{VR} = 1.0\text{V}$, GAIN=1 without PGA, unless otherwise noted

Sym.	Parameter	Test Conditions		Min.	Typ.	Max.	unit
INL	Integral Nonlinearity(INL)	$V_{DDA} = 2.4\text{V}$, $V_{VR} = 1.0\text{V}$, $\Delta SI = \pm 200\text{mV}$			± 0.003	± 0.01	%FSR
		$V_{DDA} = 2.4\text{V}$, $V_{VR} = 1.0\text{V}$, $\Delta SI = \pm 450\text{mV}$					
	No Missing Codes ³	ADC_CK=250KHz, OSR[2:0]=010b		23			Bits
G_{SD18}	Temperature drift Gain 1~x16 (INBUF[0]=0b) Gain 1~x4 (INBUF[0]=1b)	INBUF[0]=0b, VRBUF[0]=0b	$T_A = -40^\circ\text{C} \sim 85^\circ\text{C}$	2		ppm/ $^\circ\text{C}$	
		INBUF[0]=1b, VRBUF[0]=0b					
		INBUF[0]=0b, VRBUF[0]=1b					
		INBUF[0]=1b, VRBUF[0]=1b					
E_{OS}	Offset error of Full Scale Rang input voltage range with Chopper and Buffer(INBUF, VRBUF) without PGA	$\Delta AI = 0\text{V}$ $\Delta VR = 0.9\text{V}$ DCSET[2:0]=<000>	Gain=2			1	%FSR
	Offset error of Full Scale Rang input voltage range with Chopper without PGA and Buffer(INBUF, VRBUF)	* ΔAI is external short	Gain=2			1	

HY11P14

Embedded 18-Bit $\Sigma\Delta$ ADC

8-Bit RISC-like Mixed Signal Microcontroller

CM _{SD18}	Offset temperature drift with chopper without PGA and Buffer (INBUF,VRBUF).		GAIN=1	2	uV/°C			
			GAIN=2	1				
			GAIN=4	0.5				
	Offset temperature drift with chopper and Buffer (INBUF,VRBUF) without PGA.		GAIN=1	2				
			GAIN=2	1				
			GAIN=4	0.5				
	Offset temperature drift with chopper without Buffer (INBUF,VRBUF).		GAIN=128	0.02				
			Common-mode rejection	V _{CM} =0.7V to 1.7V, V _{VR} =1.0V, without PGA		V _{SI} =0V, GAIN=1	90	dB
				V _{CM} =0.7V to 1.7V, V _{VR} =1.0V, without PGA		V _{SI} =0V, GAIN=16	75	
DC power supply rejection	V _D =3.0V, Δ V _D = \pm 100mV, V _I , V _{VR} =1.0V, V _{SI} =1.2V, V _{SI} =1.2V,	GAIN=1 PGA=off	75	dB				
		GAIN=16 PGA=8						

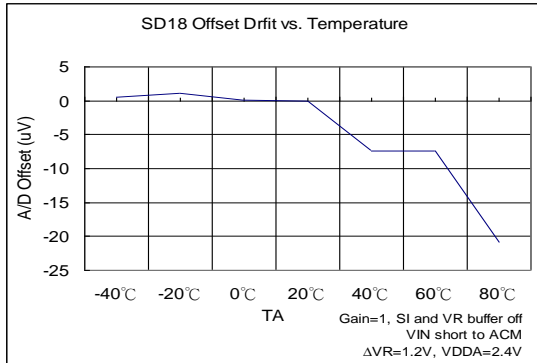

Figure 6.9-1(a) SD18 Offset Temperature drift

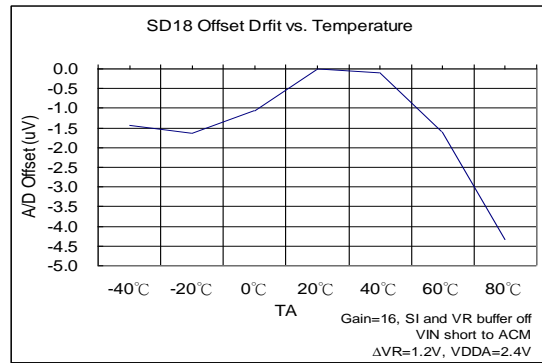

Figure 6.9-1(b) SD18 Offset Temperature drift

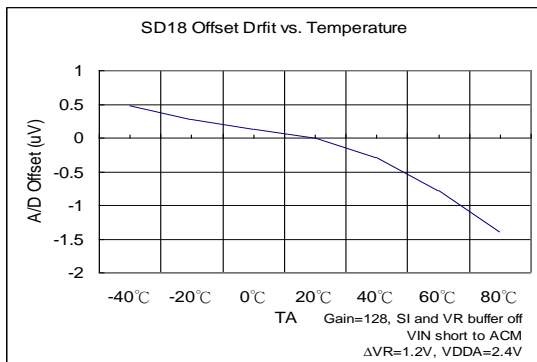

Figure 6.9-1(c) SD18 Offset Temperature drift

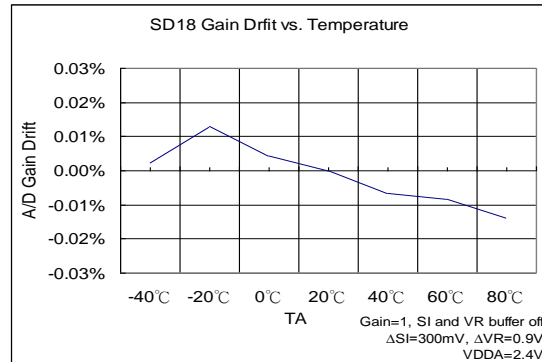

Figure 6.9-2(a) SD18 Gain drift with temperature

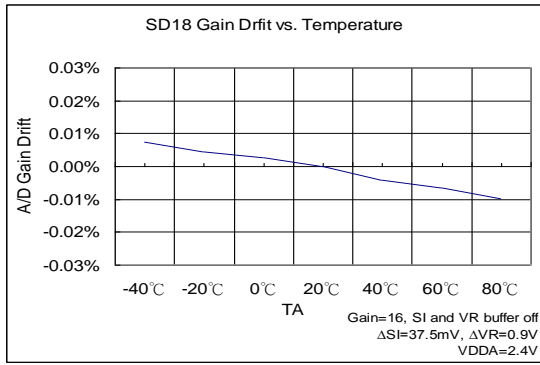

Figure6.9-2(b) SD18 Gain drift with temperature

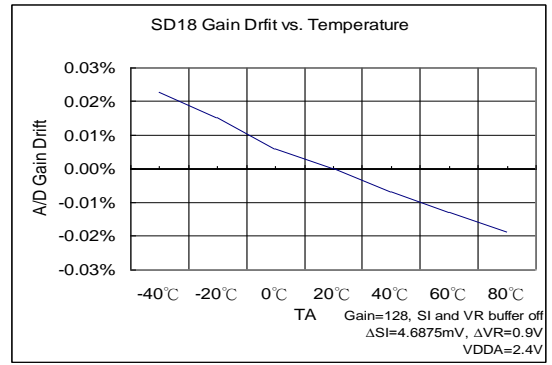

Figure6.9-2(c) SD18 Gain drift with temperature

6.12 SD18, Temperature sensor

$T_A = 25^\circ\text{C}$, $V_{DD} = 3.0\text{V}$, $V_{DDA} = 2.4\text{V}$, unless otherwise noted

Sym.	Parameter	Test Conditions	Min.	Typ.	Max.	unit
TC _S	Sensor temperature drift			178		$\mu\text{V}/^\circ\text{C}$
KT	Absolute Temperature Scale 0°K	INBUF[0]=1		-289		$^\circ\text{C}$
TC _{ERR}	One point calibrate error temperature	Calibration at 25°C of $-40^\circ\text{C} \sim 85^\circ\text{C}$		± 2		$^\circ\text{C}$

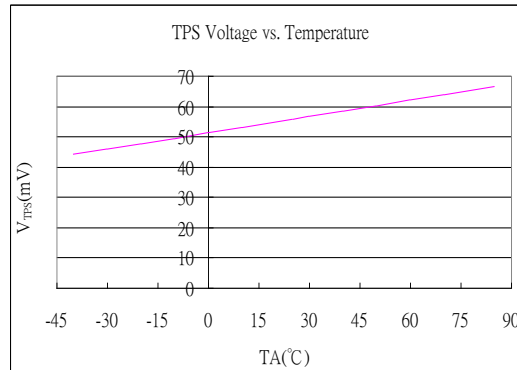

Figure 6.9-3 TPS output voltage vs. temperature drift

6.13 SD18 Noise Performance

$T_A = 25^\circ\text{C}$, $V_{DD} = 3.0\text{V}$, $V_{DDA} = 2.4\text{V}$, unless otherwise noted

HY11P14 針對 SD18 提供了重要的輸入雜訊規格。Table6.9-4(a), Table6.9-4(b) 列出典型的雜訊規格表與 Gain, Output rate, 及單端最大輸入電壓等關係。測試條件設定在外部輸入訊號短路，參考電壓為 1.2V，取樣 1024 筆資料。

ENOB(RMS) with OSR/GAIN at A/D Clock=250Khz, VDDA=2.4V, VREF=1.2V													
Max. Vin(mV) =0.9*VREF ⁽¹⁾	OSR				256	512	1024	2048	4096	8192	16384	32768	
	Output rate(HZ)				977	488	244	122	61	31	15	8	
	Gain	=	PGA	x	ADGN								
± 2400	0.25	=	1	x	0.25	16.3	17.4	17.9	18.5	19.0	19.5	20.0	20.4
± 2160	0.5	=	1	x	0.5	16.3	17.3	17.9	18.4	18.9	19.4	19.8	20.2
± 1080	1	=	1	x	1	16.2	17.2	17.8	18.3	18.8	19.3	19.7	20.1
± 540	2	=	1	x	2	16.1	17.1	17.6	18.2	18.7	19.2	19.6	20.0
± 270	4	=	1	x	4	16.0	16.9	17.5	18.0	18.5	18.9	19.4	19.8
± 135	8	=	1	x	8	15.9	16.6	17.2	17.7	18.2	18.7	19.2	19.6
± 68	16	=	1	x	16	15.6	16.3	16.8	17.3	17.7	18.3	18.8	19.3
± 34	32	=	2	x	16	14.8	15.3	15.9	16.4	16.9	17.4	17.8	18.3
± 17	64	=	4	x	16	14.5	15.0	15.5	16.0	16.5	17.0	17.5	18.0
± 8	128	=	8	x	16	14.0	14.6	15.1	15.6	16.0	16.6	17.0	17.5

(1) Max.Vin (mV) is the max. input voltage of single end to ground (VSS).

Table6.9-4(a) SD18 ENOB Table

RMS Noise(uV) with OSR/GAIN at A/D Clock=250Khz, VDDA=2.4V, VREF=1.2V													
Max. Vin(mV) =0.9*VREF	OSR				256	512	1024	2048	4096	8192	16384	32768	
	Output rate(HZ)				977	488	244	122	61	31	15	8	
	Gain	=	PGA	x	ADGN								
± 2400	0.25	=	1	x	0.25	121.08	57.40	38.74	26.66	18.39	13.21	9.49	6.98
± 2160	0.5	=	1	x	0.5	61.63	29.23	19.21	13.51	9.78	7.02	5.12	3.91
± 1080	1	=	1	x	1	32.21	15.70	10.25	7.31	5.19	3.77	2.80	2.13
± 540	2	=	1	x	2	16.59	8.54	5.91	4.06	2.86	2.06	1.48	1.12
± 270	4	=	1	x	4	9.00	4.84	3.33	2.37	1.67	1.19	0.87	0.65
± 135	8	=	1	x	8	5.04	2.97	2.02	1.44	1.01	0.73	0.51	0.39
± 68	16	=	1	x	16	3.03	1.84	1.29	0.92	0.70	0.46	0.33	0.24
± 34	32	=	2	x	16	2.61	1.81	1.27	0.89	0.62	0.45	0.32	0.23
± 17	64	=	4	x	16	1.66	1.13	0.80	0.56	0.41	0.29	0.20	0.14
± 8	128	=	8	x	16	1.13	0.77	0.55	0.38	0.28	0.19	0.14	0.10

Table6.9-4(b) SD18 RMS Noise Table

The RMS noise are referred to the input. The Effective Number of Bits (ENOB(RMS Bit)) is defined as:

$$ENOB(RMS) = \frac{\ln\left(\frac{FSR}{RMS\ Noise}\right)}{\ln(2)}$$

$$RMS\ Noise = \frac{\left(2 \times VREF \times \sqrt{\sum_{k=1}^{1024} (ADO[k] - Average)^2}\right)}{2^{23}}$$

Where FSR (Full - Scale Range) = $2 \times VREF / Gain$.

$$Average = \frac{\sum_{k=1}^{1024} (ADO[k])}{1024}$$

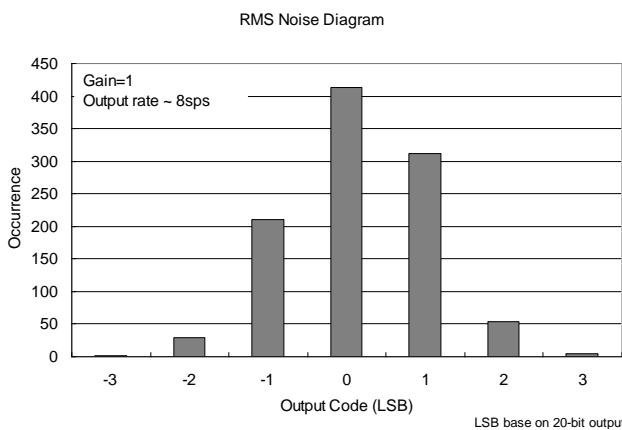

Figure6.9-4(a) RMS Noise Diagram

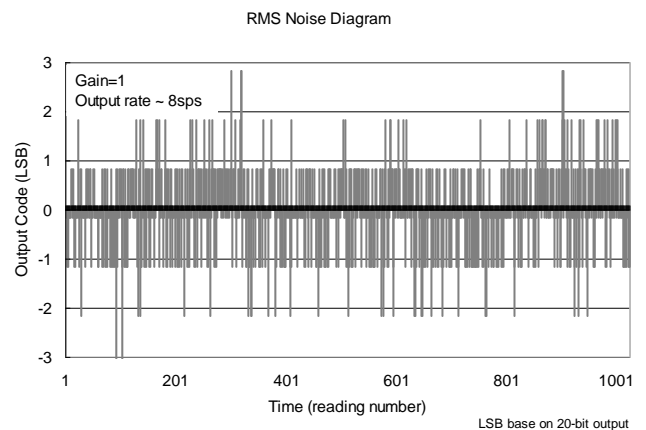

Figure6.9-4(b) Output Code Diagram

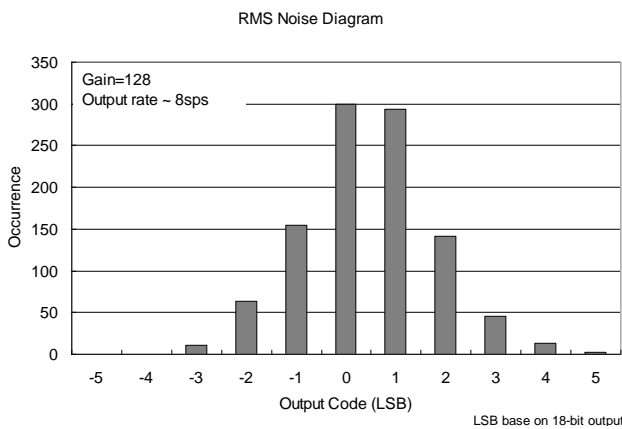

Figure6.9-4(c) RMS Noise Diagram

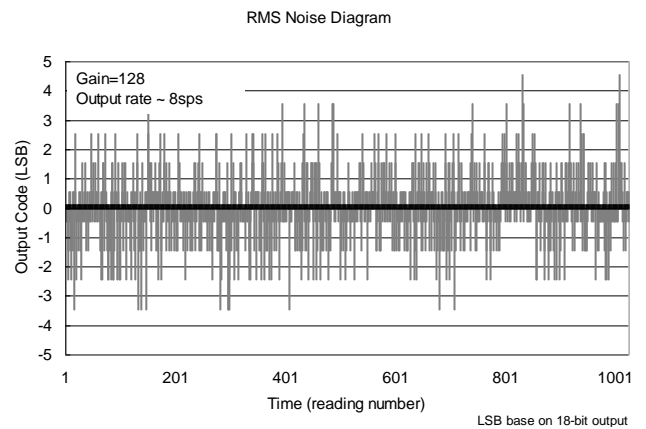

Figure6.9-4(d) Output Code Diagram

7. 訂貨資訊

下單品名 ¹	封裝型式	引腳數	封裝型式 描述方式		程式碼 編號 ²	出貨包裝 形式	個裝 數量	材料 組成	MSL ³
			D	000					
HY11P14-D000	Die	-	D	000	000	-	100	Green ⁴	-
HY11P14-L100	LQFP	100	L	100	000	Tray	90	Green ⁴	MSL-3
HY11P14-L064	LQFP	64	L	064	000	Tray	250	Green ⁴	MSL-3

1 產品名稱 – 封裝型式描述方式 – 程式碼編號 (空白片 / 標準品 / 代客燒錄碼)

例如：您的代客燒錄服務申請的程式碼編號為 008，且需要的產品是裸片出貨。則下單品名為 HY11P14-D000-008

例如：您的需求是不帶程式碼的空白片且需要的產品是裸片出貨。則下單品名為 HY11P14-D000

例如：您的需求是不帶程式碼的空白片且需要的產品是封裝片 LQFP100 出貨，則下單品名為 HY11P14-L100，且需以 Tray 出貨，則除下單品名外，請特別註明出貨包裝形式為 Tray

例如：您的代客燒錄服務申請的程式碼編號為 009，而需求的產品是封裝片 LQFP100 出貨，則下單品名為 HY11P14-L100-009，且需以 Tray 出貨，則除下單品名外，請特別註明出貨包裝形式為 Tray

2 程式碼編號

“001”~“999” 為標準品或代客燒錄申請的程式碼編號，而空白晶片不帶此碼。

3 MSL:

濕度敏感性等級係依據 IPC/JEDEC J-STD-020 的規範加以試驗分級，並參考 IPC/JEDEC J-STD-033 的標準處理、包裝、運輸與使用。

4 Green (RoHS & no Cl/Br):

HYCON 產品皆為 Green Product，符合 RoHS 指令，REACH 高關注物質(SVHC) 以及無鹵素規定(Br<900ppm or Cl<900ppm or (Br+Cl)<1500ppm)。

HY11P14

Embedded 18-Bit $\Sigma\Delta$ ADC

8-Bit RISC-like Mixed Signal Microcontroller

8. 封裝型式資訊

8.1 LQFP100(L100 10x10)

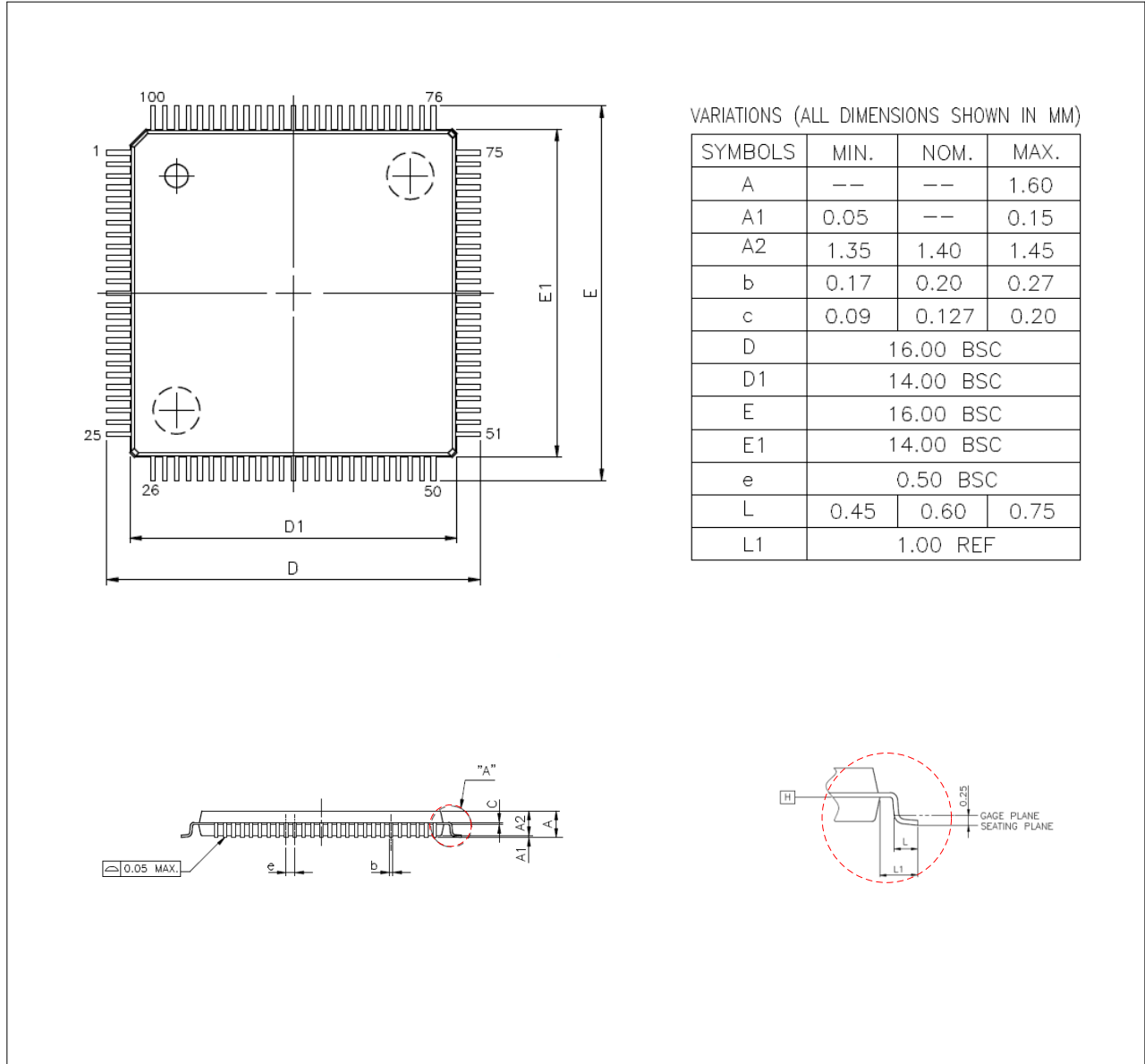

Note:

1. All dimensions refer to JEDEC OUTLINE MS-026.
2. Do not include Mold Flash or Protrusions.
3. Unit: mm.

8.2 LQFP64(L064 7x7)

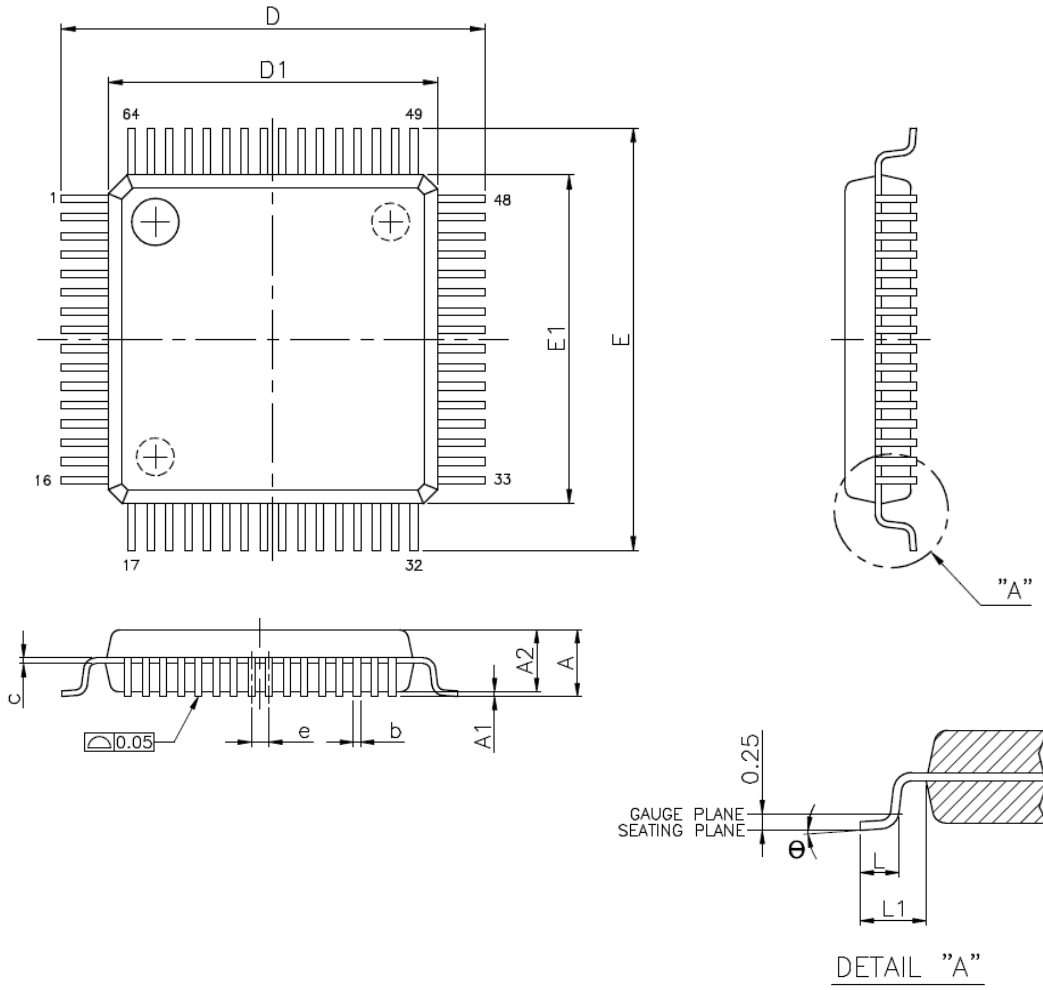

SYMBOLS	MIN.	NOM.	MAX.
A	—	—	1.60
A1	0.05	—	0.15
A2	1.35	1.40	1.45
b	0.13	0.18	0.23
c	0.09	—	0.20
D	9.00 BSC		
D1	7.00 BSC		
e	0.40 BSC		
E	9.00 BSC		
E1	7.00 BSC		
L	0.45	0.60	0.75
L1	1.00 REF		
θ	0°	3.5°	7°

Note:

1. All dimensions refer to JEDEC OUTLINE MS-026.
2. Do not include Mold Flash or Protrusions.
3. Unit: mm.

9. 修訂記錄

以下描述本文件差異較大的地方，而標點符號與字形的改變不在此描述範圍。

版本	頁次	變更摘要
V01	ALL	初版發行
V02	ALL	全面變更內容
V03	4	修訂 1 章節；增加 增強型比較器 說明
	30	修訂 7 章節；轉為中文資訊且編修欄位與內容
V04	4	修訂 68 個指令成 67 個指令，特點內容修改
	6, 9	文字內容修改，增加 PWM1/PWM2/PWM3 引腳說明
	13	增加 PASC,PWMCN,PDBD 暫存器說明
	22	Output voltage , V_{ACM} 規格修改
	23	修改 Figure6.6-5, Figure6.6-6
	25	Input offset voltage temperature drift.規格修改
	26	增加 G_{SD18} Temperature Drift 內容說明
V05	6~9	修訂章節內容
	11	修訂電路圖內容
	22~23	修訂章節內容
	26~28	修訂章節內容
V06	13	修訂章節內容
V07	4	修訂特點內容
	6	修訂 I/O 引腳定義內容
	22~23	修訂章節內容
V08	4	修訂特點內容
	22~23	修訂章節內容
V09	1	修訂封面格式
	4	修訂特點內容，刪除 1/2bias 說明
	5	增加註 3 內容說明
	11	修訂應用電路圖，增加 RST 的 RC 電路
	20	刪除 Detect V_{DD} voltage error 內容說明
V10	11	修訂圖 3-1 腳位數字
	12	修增加圖 4-1 PORT PT3 說明
	13	增加 SD18 Network 章節
	23	修訂 Power System 溫飄規格
	30~31	增加 SD18 Noise Performance 章節
V11	4	修改 1.特點內容
	16	修改 6.電氣規格內容

	32	修改 RMS Noise Diagram
V12	12	修改開發工具相關使用說明書編號
	13	修改圖 4-2 INH/INL
	24	修改圖片背景顏色
	33	增加訂貨資訊內容
V13	25	更新 I _{LCD} 電流規格
V14	14	增加 Low Noise OPAMP Network
	15	增加 Enhance Comparator Network
V15	All	增加 LQFP64 封裝資料
V16	7~11	修改 LQFP64 封裝第 21 腳的引腳名稱及定義
	37	更新 Green (RoHS & no Cl/Br)